

EUROCUCINA 2018

**Poliform**

**Poliform**

Un progetto protagonista di tre proposte, all'insegna dell'eccellenza sotto tutti gli aspetti. Il nostro stand a Eurocucina, per la prima volta firmato Poliform, mette al centro il nuovo modello Shape e lo esplora offrendone tre diverse interpretazioni. In questa sequenza, l'ambiente cucina si scopre via via più sofisticato: per l'organizzazione professionale degli spazi, per le forme inedite, per la selezione di materiali di pregio, in grado di unire estetica, affidabilità e durata nel tempo. Tre progetti che rispecchiano tre modi d'essere e di vivere la cucina.

Three different proposals are protagonist of the project of our booth at Eurocucina show, for the first time signed Poliform. The new model Shape is the focus of the show, explored with three different layouts. In this sequence, the kitchen becomes more and more sophisticated, for the professional organization of the space, for the original shapes, for high quality material selection merging aesthetics, reliability and durability over time. These three projects reflect three different ways of being and living in the kitchen.

COLLECTIONS

EUROCUCINA	7
SHAPE COMPOSITION N. 01	17
SHAPE COMPOSITION N. 02	37
SHAPE COMPOSITION N. 03	47
SHAPE COMPOSITION N. 04	65
SOPHIE STOOL	89
MATERIALS AND FINISHINGS	94



# EUROCUCINA

Ogni composizione mostra una diversa configurazione dello spazio: dalla cucina con due aree separate a quella di grandi dimensioni. La zona conviviale è sempre in primo piano.

Every kitchen shows a different layout: from the kitchen with two separated areas to the one of big size. The convivial area is always in foreground.





I piani snack dalle forme tonde rompono la rigidità compositiva della cucina, tradizionalmente caratterizzata da linee rigide e squadrate, e rendono l'area operativa più leggera e contemporanea.

The round-shaped snack tables break the traditionally straight and squared lines of the kitchen and make the working area lighter and more contemporary.





Il rovere di palude, un legno dalla storia secolare, è la nuova finitura presentata in esclusiva. Grande ricerca anche per gli altri materiali come acciai graffiati, laccature metalliche in rame, bronzo e titanio, marmi e pietre naturali.

Bog oak, a wood of centuries-old history, is the new exclusive finish. A great material research such as anodized steel, metallic lacquers in copper, bronze and titanium colour, marbles and natural stones distinguished the presentation.











# SHAPE







Cucina Shape laccato lucido tortora con maniglia integrata finitura bronzo. Top in marmo lucido emperador extra dark. Sistema modulare Infinity personalizzato Poliform, acciaio e vetro. Snack Moon massello rovere di palude e marmo lucido emperador extra dark. Sgabelli Ventura in olmo nero rivestimento non sfoderabile in pelle Soft 10 prugna. Nella pagina a sinistra: colonne High Shape, struttura nobilitato grigio lavagna, ante laccato lucido tortora, cassetti in acciaio e barra luminosa Led, anodizzata nera. Sotto: dettaglio del ripiano estraibile in acciaio.

Kitchen Shape glossy lacquered tortora with integrated handle in bronze finish. Counter top in glossy marble emperador extra dark. Modular system Infinity personalized Poliform in steel and glass. Snack counter Moon in solid bog oak and glossy marble emperador extra dark. Stools Ventura in black elm covered in non-removable leather Soft 10 prugna. Left page: tall units High Shape, structure in melamine grigio lavagna, ante laccato lucido tortora, cassetti in acciaio e barra luminosa Led, anodizzata nera. Sotto: close up of the extractable shelf in steel.









Snack Moon struttura e piano massello rovere di palude, inserto centrale marmo lucido emperador extra dark. Sgabelli Ventura in olmo nero rivestimento non sfoderabile in pelle Soft 10 prugna. Sotto: dettaglio che evidenzia il particolare incastro tra la gamba e il piano snack.

Snack counter Moon with structure and top in solid bog oak, central inlay in glossy marble emperador extra dark. Stools Ventura in black elm covered in non-removable leather Soft 10 prugna. Below: close up of the particular joint of leg and snack counter.

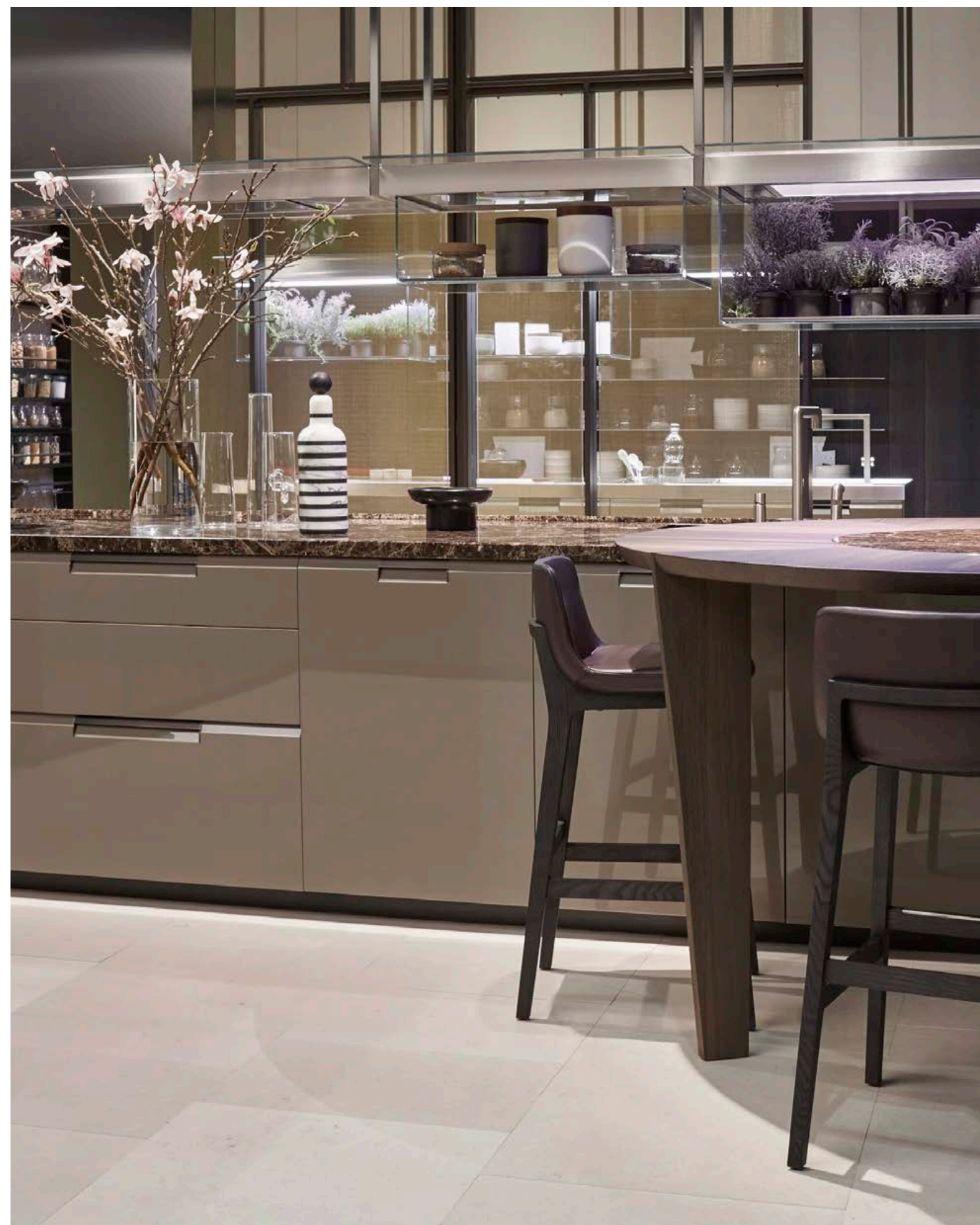







Nella pagina precedente: sistema modulare Infinity personalizzato Poliform, acciaio e vetro con modulo luminoso aspirante, modulo luminoso portaspezie e modulo luminoso fitostimolante.

Nella pagina a destra: dettaglio piano in marmo emperador extra dark lucido sp. 40 mm con invaso rastremato. Sotto: dettaglio delle prese elettriche a scomparsa, finitura nera.

Previous page: modular system Infinity, personalized Poliform, in steel and glass with lighted aspiration unit, lighted spice holder unit and lighted phytostimulating unit. Right page: close up of the counter top in glossy marble emperador extra dark thickness 40 mm with tapered drip edge. Below: close up of the concealed electrical sockets in black finish.

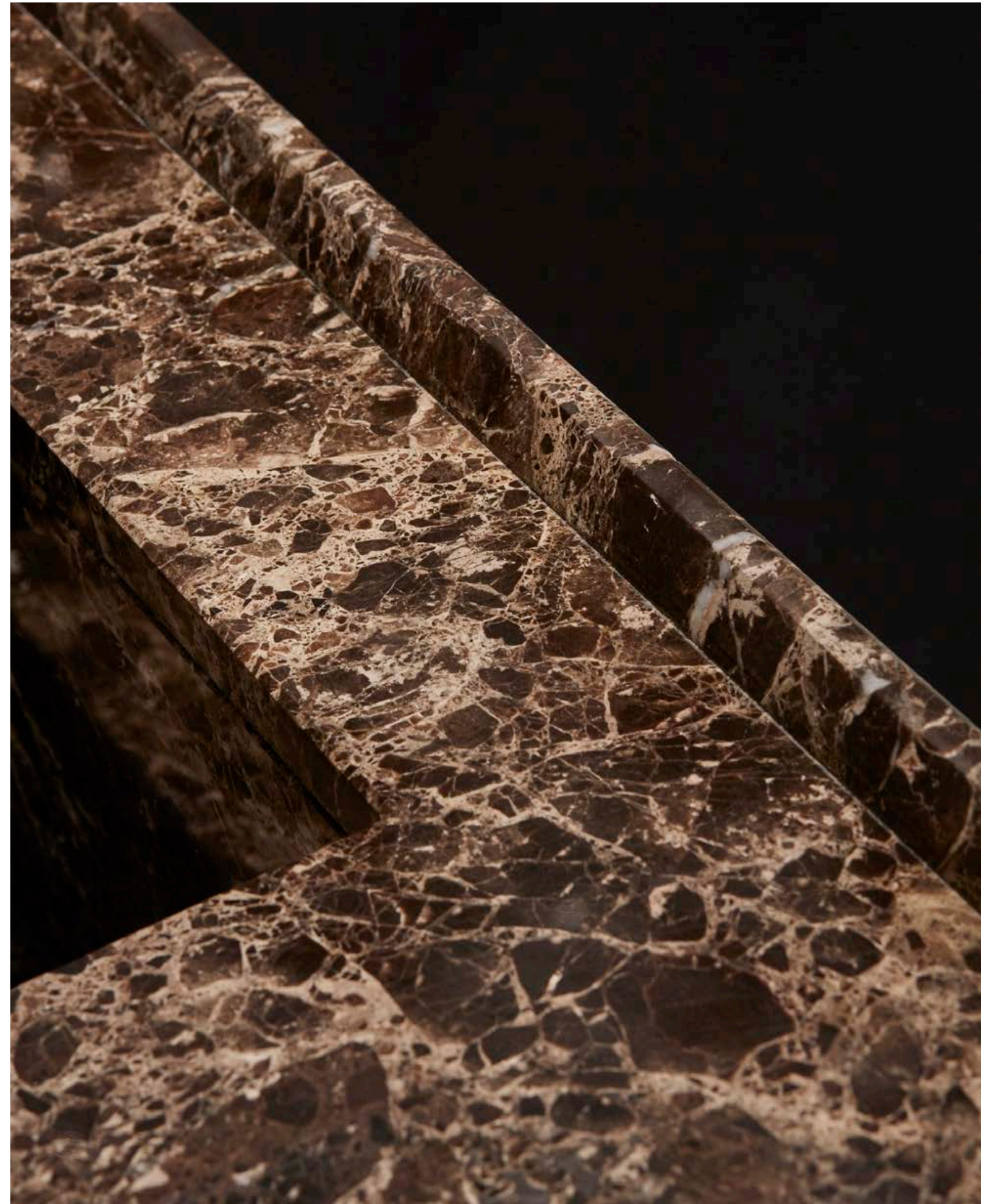







Madia Kontainer in olmo nero, ante a scomparsa con nuovo meccanismo, maniglia integrata. Struttura interna, laccato metallico bronzo, cassetteria interna con frontale Alea Plus, profilo anodizzato nero e vetro fumè, profilo orizzontale di apertura Alea alluminio anodizzato nero. Piano cassetteria, vetro fumè con profilo anodizzato nero o ceramica texturizzata colore nero e profilo anteriore anodizzato nero. Ripiani interni, profilo verniciato nero e vetro fumè. Sgabelli Ventura in olmo nero rivestimento non sfoderabile in pelle Soft 10 prugna. Sotto: dettaglio maniglia integrata finitura laccato metallico bronzo.

Sideboard Kontainer in black elm, retractable doors with new mechanism, integrated handle. Inner structure in bronzo metal lacquer, inner chest of drawers with Alea Plus front, black anodized profile and fume glass, horizontal opening profile Alea in black anodized aluminium. Chest of drawers top in fume glass with black anodized profile or textured ceramic in black colour and black front profile. Inner shelves in fume glass with black anodized profile. Stools Ventura in black elm covered with non-removable leather Soft 10 prugna. Below: close up of the integrated handle in bronzo metal lacquered finish.



**Basi isola**

Struttura: nobilitato grigio lavagna.  
 Ante: laccato lucido tortora.  
 Maniglia: integrata Shape, centrale, finitura bronzo.  
 Top: sp. 40mm con vaso rastremato, marmo emperador extra dark, finitura lucida.  
 Lavello: emperador extra dark, finitura lucida.  
 Portaposate: wengè.  
 Cassetti ed estrattori: verniciato brown.  
 Zoccolo: h.70mm laccato goffrato moka.

**Snack Moon**

Ø 1800mm, massello rovere di palude ed emperador extra dark, finitura lucida.

**Colonne High Shape**

Struttura: nobilitato grigio lavagna.  
 Ante High Shape: laccato lucido tortora.  
 Maniglia: integrata Shape, centrale, finitura bronzo.  
 Portaposate: alluminio.  
 Cassetti ed estrattori: verniciato brown, massello noce canaletto (cassetti e estrattori interni).  
 Zoccolo: h. 70mm laccato goffrato moka.

**Elettrodomestici**

Gaggenau. Sistema modulare Infinity personalizzato Poliform, acciaio e vetro (modulo luminoso aspirante, modulo luminoso portaspezie, modulo luminoso fitostimolante).

**Madia Kontainer**

Struttura esterna: olmo nero.  
 Struttura interna: laccato metallico bronzo.  
 Cassettiera: ante AleaPlus, profilo anodizzato nero e vetro fumè, profilo orizzontale di apertura Alea alluminio anodizzato nero.  
 Piano cassettiera: vetro fumè con profilo anodizzato nero o ceramica texturizzata colore nero e profilo anteriore anodizzato nero.  
 Ripiani interni: profilo verniciato nero e vetro fumè.  
 Portaposate: wengè.

**Sgabelli Ventura alto**

Jean-Marie Massaud  
 Struttura: olmo nero.  
 Rivestimento: non sfoderabile in pelle Soft 10 prugna.

**Island base units**

Structure: lavagna grey melamine.  
 Doors: glossy lacquered tortora.  
 Handle: integrated Shape, bronze finishing.  
 Worktop: th.40mm, chamfered drip edge, marble emperador extra dark, glossy finishing.  
 Sink: marble emperador extra dark, glossy finishing.  
 Cutlery canteen: wengè.  
 Drawers and pullout-drawers: aluminum brown finishing.  
 Plinth: h.70mm, embossed lacquered moka.

**Snack Moon**

Ø mm 1800, solid bog oak, marble emperador extra dark, glossy finishing.

**Tall units High Shape**

Structure: lavagna grey melamine.  
 Doors High Shape: glossy lacquered tortora.  
 Handle: integrated Shape, bronze finishing.  
 Cutlery canteen: aluminum.  
 Drawers and internal pullout-baskets: aluminum brown finishing, solid walnut canaletto.  
 Plinth: h.70mm, embossed lacquered moka.

**Appliances**

Gaggenau. Customized Infinity modular system by Poliform, stainless steel and glass (lighting extractor module, lighting module spice rack and lighting module with phytoled lights).

**Madia Kontainer**

External structure: black elm.  
 Internal structure: metal lacquer bronzo.  
 Internal drawer unit: fronts Alea Plus, black anodized frame with fumè glass. Alea black anodized profiles.  
 Top for internal drawers unit: fumè glass with black anodized profiles nero texturized ceramic with frontal black anodized frame.  
 Inner shelves: fumè glass with black anodized profiles.  
 Cutlery canteen: wengè.

**High Ventura stools**

Jean-Marie Massaud  
 Structure: black elm.  
 Cover: non removable in Soft 10 prugna leather.

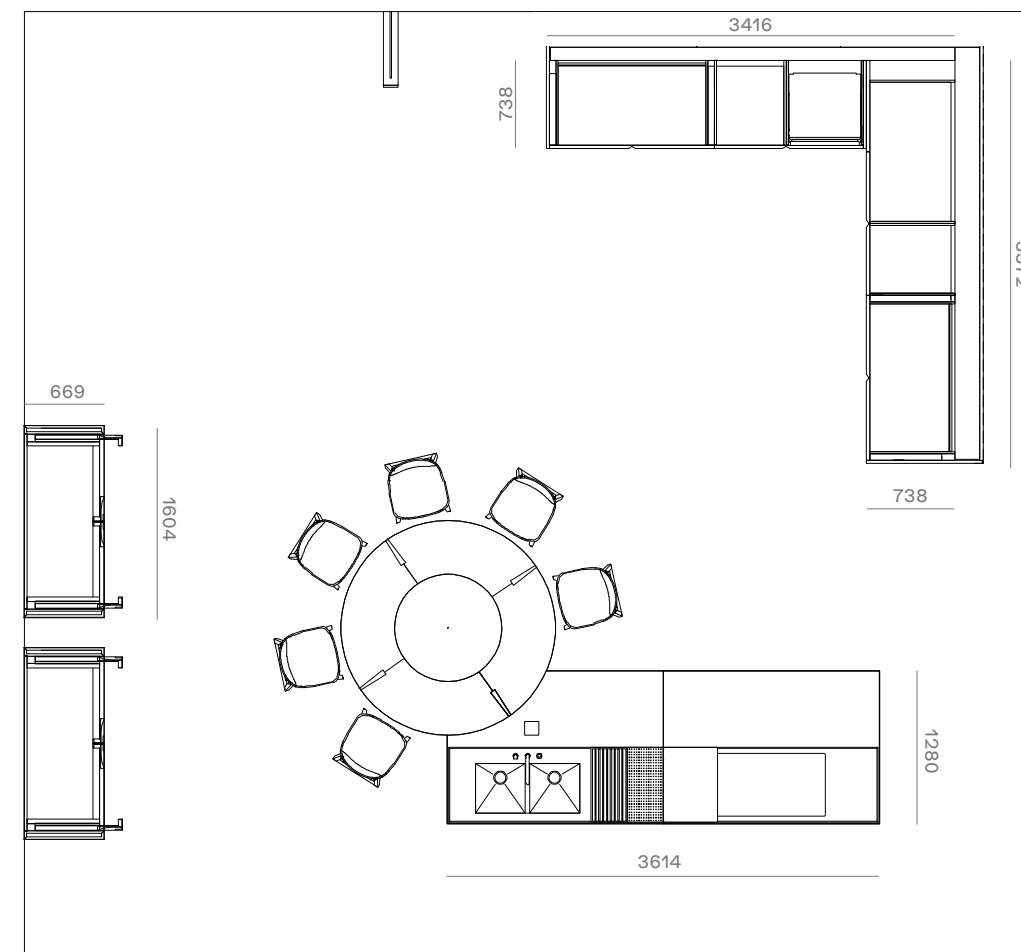



# SHAPE









Cucina Shape acciaio con maniglia integrata laccato gofrato moka. Top in acciaio Barazza finitura scotch brite e vaso rastremato, gamba di sostegno Minus alluminio laccato gofrato moka. Sistema modulare Infinity, personalizzato Poliform con modulo luminoso, modulo luminoso porta-spezie e modulo luminoso fitostimolante, acciaio e vetro. Boiserie rovere di palude con mensole acciaio e schienale modulare Shaker. Nella pagina a destra: Shaker struttura alluminio anodizzato moka, schienale laccato gofrato tortora e tubi laccato gofrato moka. Piano attrezzato con tagliere in noce nazionale, tagliere forato e griglia poggia pentole in acciaio.

Kitchen Shape in steel with moka embossed lacquered integrated handle. Counter top in steel Barazza scotch brite finish and tapered drip edge, supporting leg Minus in moka embossed lacquered aluminium. Modular system Infinity personalized Poliform with lighted unit, lighted spice holder unit and lighted phytostimulating unit, in steel and glass. Wall panelling in bog oak with steel shelves and modular back Shaker. Right page: Shaker with structure in moka anodized aluminium, tortora embossed lacquered back and moka embossed lacquered bars. Equipped counter with chopping board in Italian walnut, perforated chopping board and steel pan support.









**Basi**

Struttura: nobilitato grigio perla.  
 Ante: acciaio.  
 Maniglia: integrata Shape, centrale, laccato goffrato moka.  
 Top: sp.60 mm con invaso rastremato, acciaio  
 Barazza finitura scotch brite.  
 Accessori: tagliere noce nazionale, tagliere forato e griglia poggia pentole in acciaio.  
 Cassetti ed estrattori: alluminio anodizzato con frontale personalizzato alluminio anodizzato satinato.  
 Portaposate: military touch.  
 Minus, gamba di sostegno penisola: alluminio laccato goffrato moka.  
 Zoccolo: h.70 mm laccato goffrato moka.

**Shaker**

Struttura: alluminio anodizzato moka.  
 Schienale: laccato goffrato tortora.  
 Listello: laccato goffrato moka.

**Boiserie**

Pannelli: rovere di palude.  
 Mensole: acciaio sp.3mm.

**Elettrodomestici**

Sistema modulare Infinity personalizzato Poliform, acciaio e vetro (modulo luminoso, modulo luminoso portaspezie, modulo luminoso fitostimolante).

**Base units**

Structure: Perla Grey melamine.  
 Doors: stainless steel.  
 Handle: integrated Shape, embossed lacquered moka.  
 Worktop: th.60mm, chamfered drip edge, Barazza stainless steel scotch brite finishing.  
 Accessories: Italian walnut chopping board, drilled steel chopping board with steel table rack for pans.  
 Drawers and pullout-drawers: anodized aluminium with customized front anodized satin aluminium.  
 Cutlery canteen: military touch.  
 Minus, peninsula support leg: aluminum embossed lacquered moka.  
 Plinth: h.70mm, embossed lacquered moka.

**Shaker**

Structure: aluminum anodized moka.  
 Back panel: lacquered embossed tortora.  
 Pipe: lacquered embossed moka.

**Boiserie**

Panels: bog oak.  
 Shelves: stainless steel shelves th.3mm.

**Appliances**

Customized Infinity modular system by Poliform, stainless steel and glass (lighting module, lighting module with spicerack, lighting module with phytoled lights).ipsa dem laut aut id mod untiatius

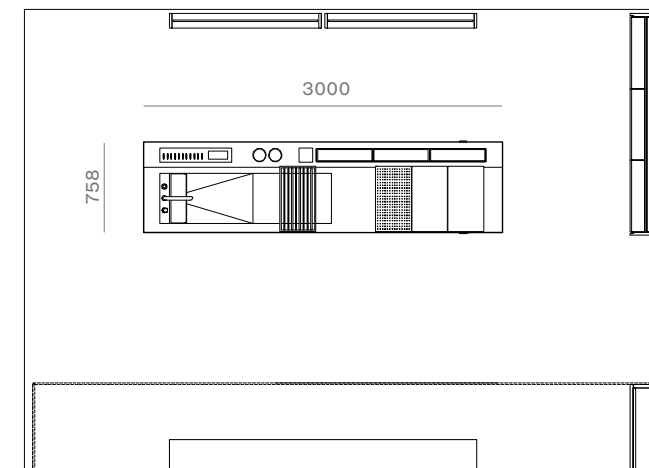





# SHAPE







Cucina Shape basi isola e basi parete massello rovere di palude con maniglia integrata laccato goffrato moka, colonne laccato goffrato vischio, maniglia integrata laccato goffrato moka. Top basi isola acciaio satinato Blanco con telaio di supporto in alluminio. Top basi parete in quarzite con invaso rastremato. Sistema di aspirazione modulare Infinity, personalizzato Poliform, modulo luminoso aspirante e modulo luminoso, acciaio e vetro. Sgabelli Ventura struttura olmo nero, rivestimento non sfoderabile in tessuto Zante 10 nero. A destra: Deep Shaker, alluminio anodizzato moka, schienale ceramica texturizzata colore silver, tubi acciaio scotch brite. Anta scorrevole, profilo alluminio anodizzato moka e vetro line fumè. Sotto: dettaglio del portaposate laminato military touch e alluminio.

Kitchen Shape, island base units and base units in solid bog oak with moka embossed lacquered integrated handle, vischio embossed lacquered tall units, moka embossed lacquered integrated handle. Island base units counter top in Blanco brushed steel with aluminium supporting frame. Base units counter top in composite stone with tapered drain edge. Modular aspiration system Infinity, lighted aspiration unit and lighted unit in steel and glass. Stools Ventura in black elm, non-removable covering in fabric Zante 10 nero. Right: Deep Shaker, moka anodized aluminium, back in textured ceramic silver colour, bars in steel scotch brite. Sliding door, moka anodized aluminium frame and glass line fume. Below: close up of cutlery canteen in military touch laminate and aluminium.





Nella pagina a destra: basi con cassetti ed estrattori in rovere di palude e maniglia integrata Shape, plafone smussato con nuova profondità e luce integrata. Colonne e pensili in laccato goffrato vischio con maniglia integrata Shape laccato goffrato moka. Piano in quarzite con vaso rastremato. Sotto: attrezzatura Deep Shaker, cassettoni in noce canaletto tubo acciaio scotch brite e anta scorrevole, profilo alluminio anodizzato moka e vetro line fumè.

Right page: base units with drawers and pullout storage baskets in bog oak and integrated Shape handle, tapered top shelf with new depth and integrated light. Tall units and wall units in embossed lacquered vischio with moka embossed lacquered integrated Shape handle. Counter top in composite stone with tapered drain edge. Below: equipment Deep Shaker, little drawers in Canaletto walnut, scotch brite steel bar and sliding door, moka anodized aluminium frame and glass line fumè.

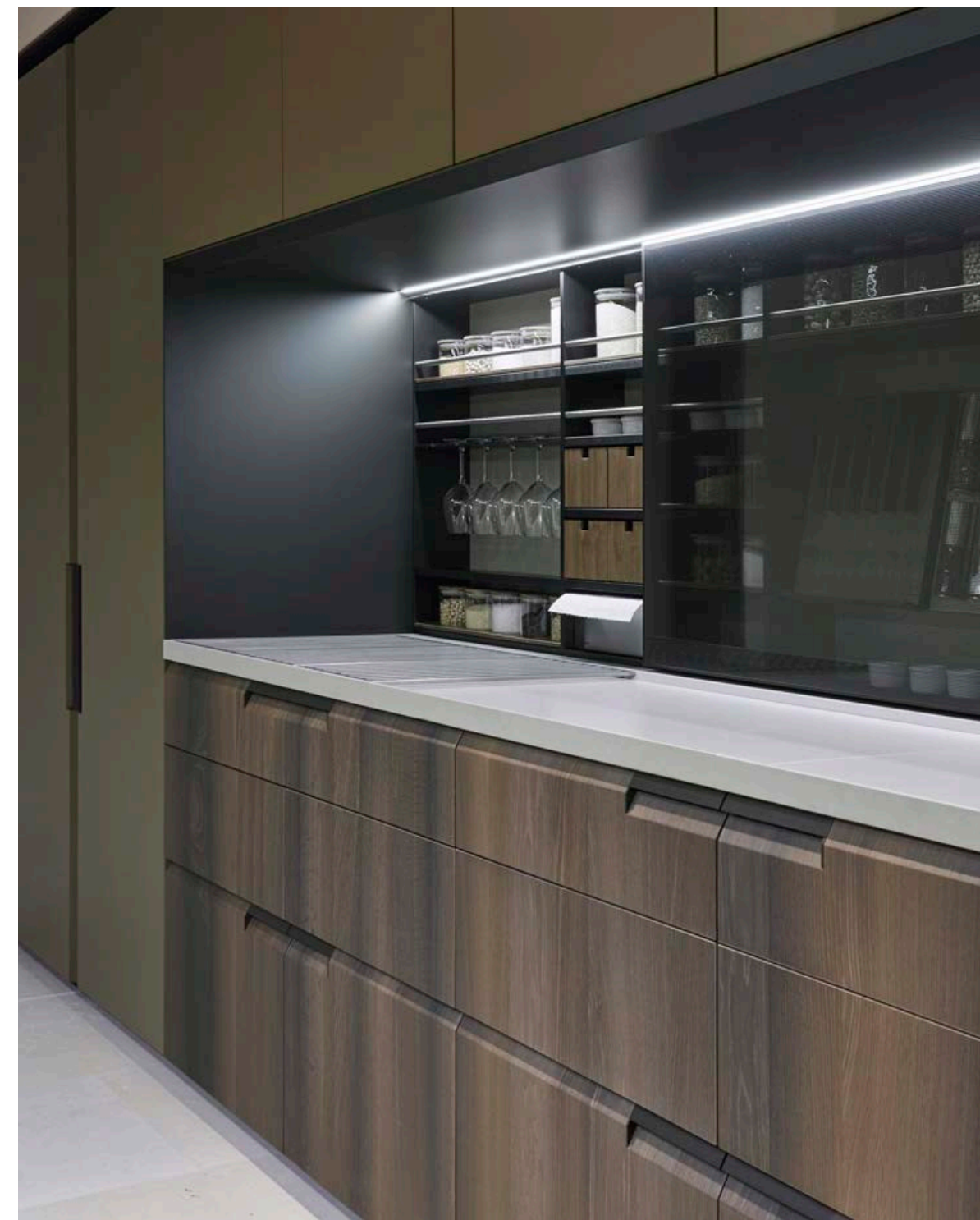







Nella pagina precedente, colonne con ante High Shape massello rovere di palude. Nella pagina a destra: dettaglio dei cassetti interni in rovere di palude. Sotto: dettaglio dell'anta con maniglia integrata Shape laccato goffrato moka.

Previous page, tall units with doors High Shape in solid bog oak. Right page: close up of the inner drawers in bog oak. Below: close up of the door with integrated Shape handle embossed lacquered moka.

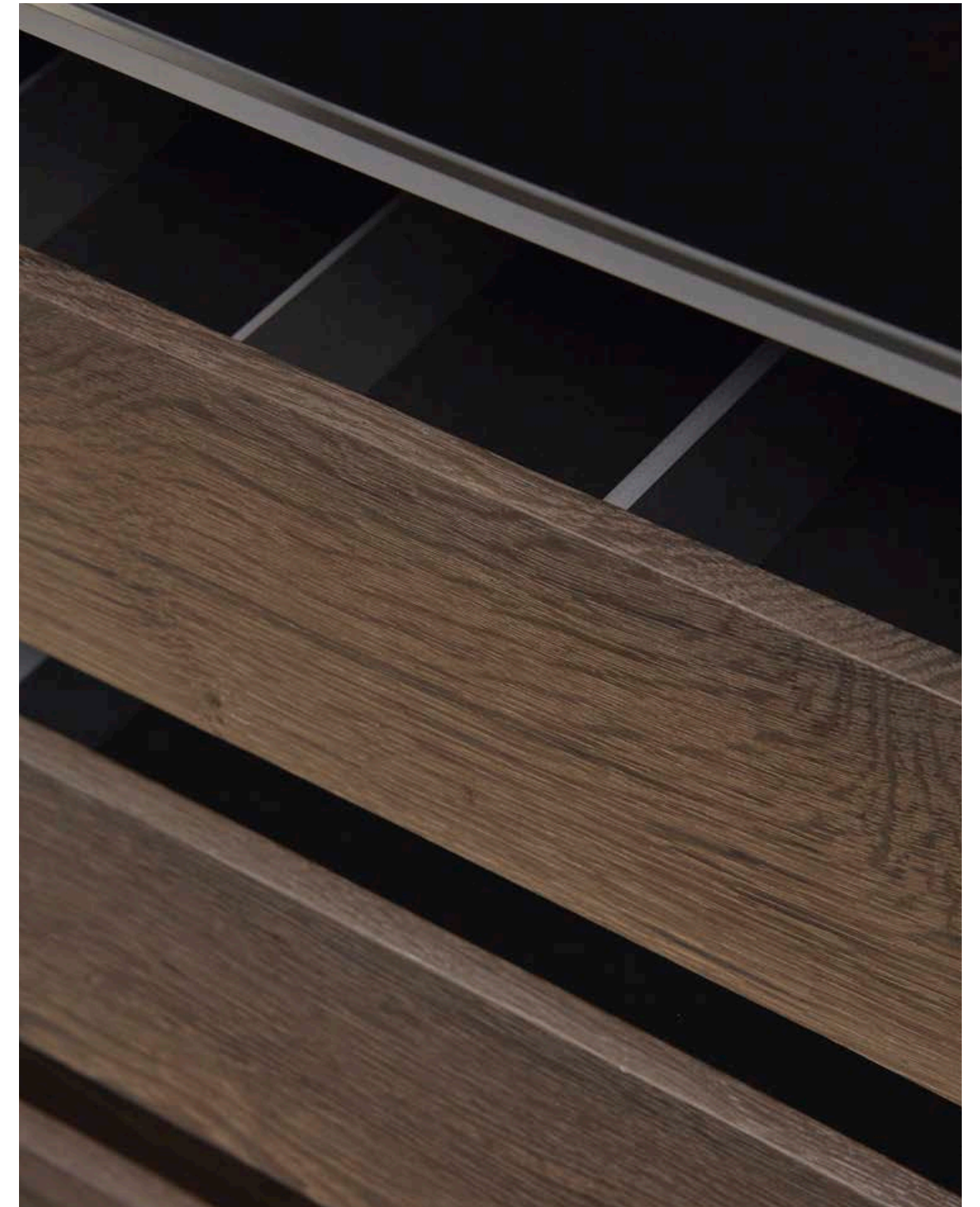







Nella pagina precedente e a destra: colonne vetrina profilo anodizzato moka PR23 con maniglia integrata e vetro line fumé. Sotto dettaglio profilo PR23 con maniglia integrata.

Previous page and right: glass tall units with moka anodized PR23 profile with integrated handle and glass line fumé. Below: close up of PR23 profile with integrated handle.

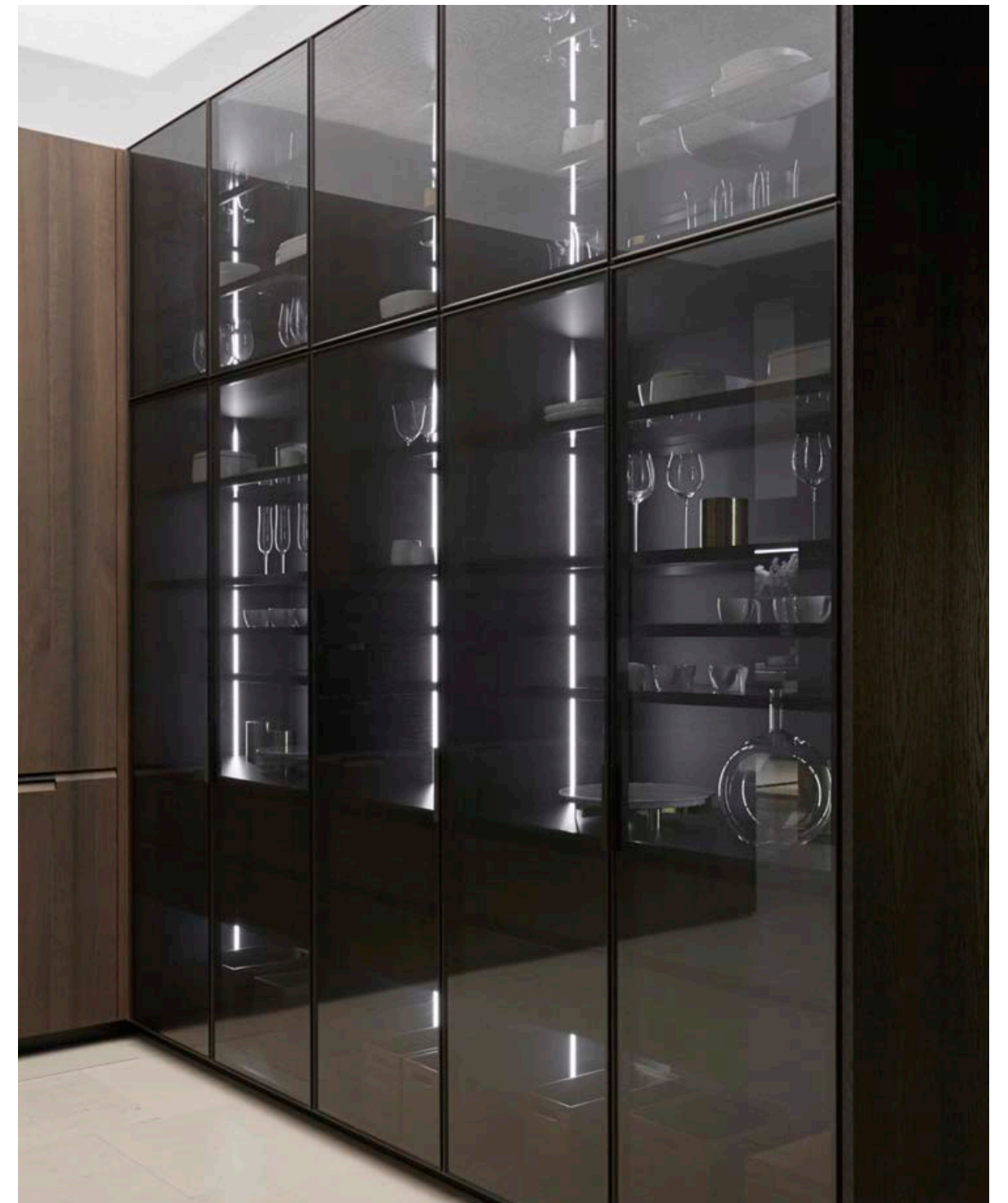
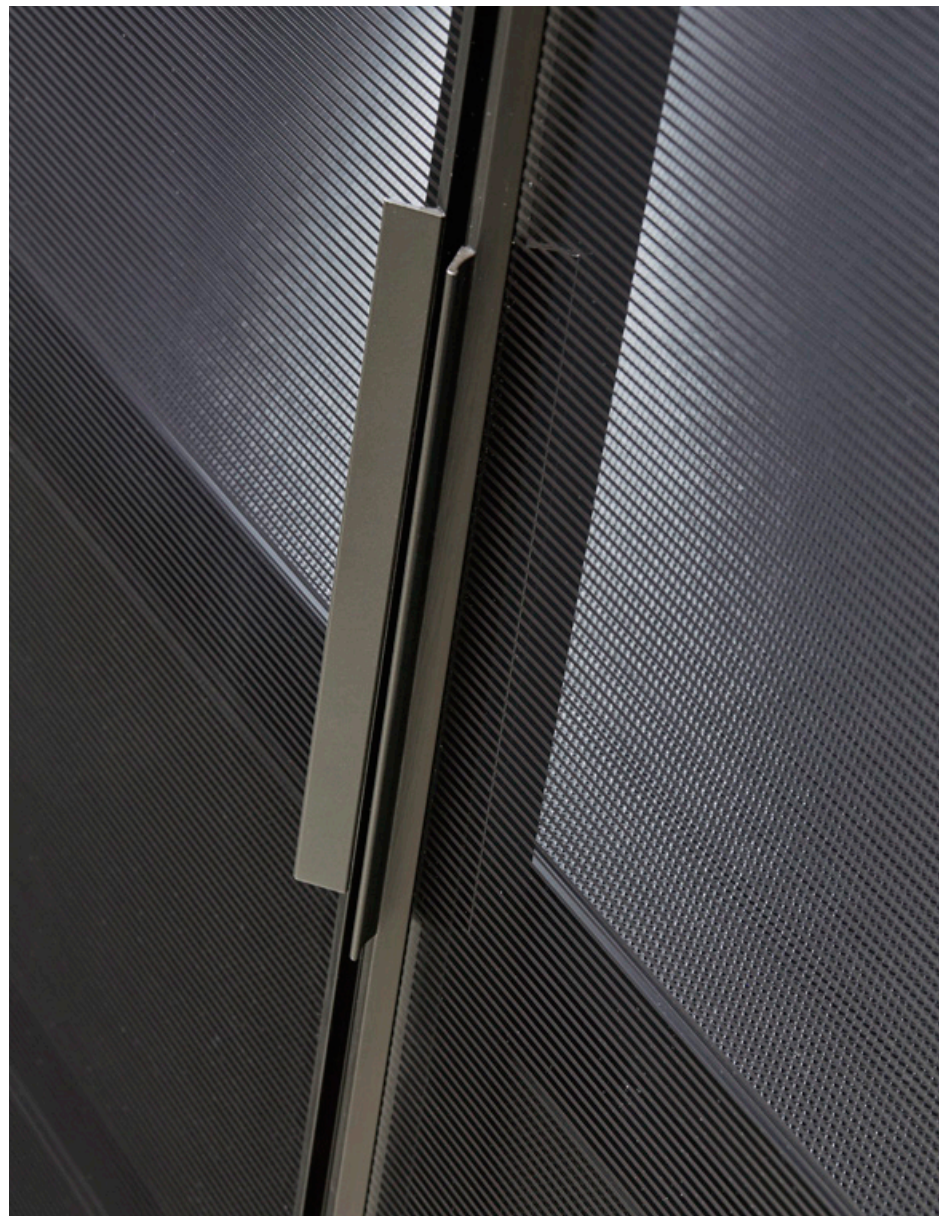



#### Basi isola

Struttura: nobilitato grigio perla.  
Ante: massello rovere di palude.  
Maniglia: integrata Shape, laccato goffrato moka.  
Top: sp.6mm con telaio in alluminio di supporto, acciaio Blanco, finitura satinata.  
Cassetti ed estrattori: sponde alluminio anodizzato con frontale personalizzato alluminio anodizzato satinato.  
Portaposate: military touch e alluminio.  
Zoccolo: h.70mm laccato goffrato moka.

#### Snack Ring

mm 2375 x 1250, massello rovere di palude e ceramica texturizzata colore silver.

#### Sgabelli Ventura alto

Jean-Marie Massaud  
Struttura: olmo nero.  
Rivestimento: non sfoderabile in tessuto Zante 10 nero.

#### Colonne

Struttura: nobilitato grigio lavagna.  
Ante High Shape: massello rovere di palude.  
Maniglia: integrata Shape, laccato goffrato moka.  
Zoccolo: h.70mm laccato goffrato moka.  
Cassetti ed estrattori interni: massello rovere di palude.

#### Colonne vetrina

Struttura: nobilitato grigio lavagna.  
Ante: profilo PR23 anodizzato moka e vetro line fumè.  
Cassettiere interne: ante modello Alea Plus, telaio anodizzato nero e ceramica texturizzata colore nero; maniglia profilo orizzontale di apertura modello Alea, alluminio anodizzato nero; top sp.20mm, ceramica texturizzata colore nero, con profilo anteriore anodizzato nero.  
Cassetti ed estrattori: verniciato brown.  
Zoccolo: h.70mm laccato goffrato moka.

#### Colonne parete

Struttura: nobilitato grigio perla.  
Ante colonne: laccato goffrato vischio.  
Maniglia: integrata Shape, laccato goffrato moka.  
Zoccolo: h.70mm laccato goffrato moka.

#### Basi parete

Struttura: nobilitato grigio perla.  
Ante: massello rovere di palude.  
Maniglia: integrata Shape, laccato goffrato moka.  
Top: sp.40mm, con vaso rastremato, quarzite portland grey, finitura micropallinato.  
Accessori: tagliere noce nazionale e griglia poggia pentole in acciaio.  
Zoccolo: h.70mm laccato goffrato moka.

#### Deep Shaker

Struttura: alluminio anodizzato moka, p.160mm.  
Schienale: ceramica texturizzata colore silver.  
Listello: acciaio scotch brite.  
Anta scorrevole: profilo alluminio anodizzato moka e vetro line fumè.

#### Elettrodomestici

Miele. Sistema modulare Infinity personalizzato Poliform, acciaio e vetro (modulo luminoso aspirante e modulo luminoso).

#### Island base units

Structure: perla grey melamine.  
Doors: solid bog oak.  
Handle: integrated Shape, embossed lacquered moka.  
Worktop: th.6mm with aluminum support, Blanco, steel satin finishing.  
Drawers and pullout-drawers: anodized aluminum with customized front anodized satin aluminum.  
Cutlery canteen: military touch and aluminum.  
Plinth: h.70mm, embossed lacquered moka.

#### Snack Ring

Size 2375x1250 mm, solid bog oak and silver texturized ceramic.

#### High Ventura stools

Jean-Marie Massaud  
Structure: black elm.  
Covering: non removable in fabric Zante 10 black.

#### Tall units

Structure: lavagna grey melamine.  
Doors High Shape: solid bog oak.  
Handle: integrated Shape, embossed lacquered moka.  
Plinth: h.70mm, embossed lacquered moka.  
Drawers and internal pulloutbaskets: solid bog oak.

#### Glass tall units

Structure: lavagna grey melamine.  
Doors: profilo PR23 moka anodized with line fumè glass.  
Internal drawer unit: fronts Alea Plus, black anodized frame with nero texturized ceramic.  
Alea black anodized profiles, countertop nero texturized ceramic with frontal black anodized frame.  
Drawers and pullout-baskets: aluminum brown finishing.  
Plinth: h.70mm, embossed lacquered moka.

#### Tall units

Structure: perla grey melamine.  
Doors: embossed lacquered vischio.  
Handle: integrated Shape, embossed lacquered moka.  
Plinth: h.70mm, embossed lacquered moka.

#### Base units on the wall

Carcass: perla grey melamine.  
Doors: solid bog oak Handle: integrated Shape, embossed lacquered moka.  
Worktop: th.40mm, chamfered drip edge, bead-blasted portland grey composite stone.  
Accessories: Italian walnut chopping board, steel table rack for pans.  
Plinth: h.70mm, embossed lacquered moka.

#### Deep Shaker

Structure: moka anodized aluminum, d.160mm.  
Backpanel: silver texturized ceramic.  
Pipe: steel scotch brite finishing.  
Sliding door: moka anodized aluminum profile with line fumè glass.

#### Appliances

Miele. Customized Infinity modular system by Poliform, stainless steel and glass (lighting extractor module and lighting module).

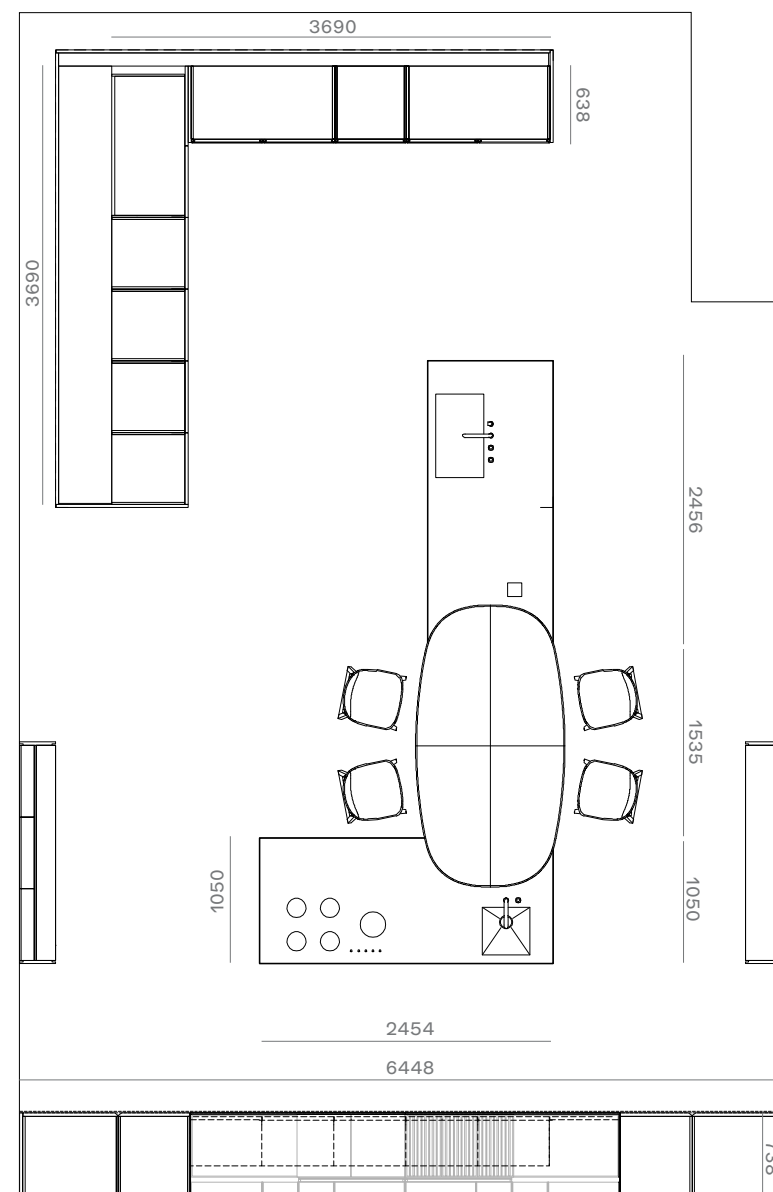

# SHAPE









Cucina Shape basi isola laccato metallico rame con maniglia integrata laccato goffrato moka, top Dekton calacatta. Penisola con piano acciaio Barazza finitura scotch brite e vaso rastremato, gamba di sostegno Minus alluminio laccato goffrato moka, attrezzato con tagliere in noce nazionale, tagliere forato e griglia poggiapentole in acciaio. Snack Moon massello rovere di palude e vetro fumé retroverniciato moka. Sgabelli Sophie olmo nero poggiapiedi in brown nickel opaco, rivestimento non sfoderabile in pelle Soft 8 visone. Sistema modulare Infinity, personalizzato Poliform con modulo luminoso aspirante, modulo luminoso portaspesie e modulo luminoso fitostimolante, acciaio e vetro. Basi a parete massello rovere di palude con maniglia integrata laccato goffrato moka, top in acciaio Barazza finitura scotch brite. Deep Shaker struttura alluminio anodizzato moka, schienale laccato metallico rame. Colonne vetrina profilo anodizzato moka PR23 con maniglia integrata e vetro line fumé.

Kitchen Shape with island base units in rame metal lacquer with moka embossed lacquered integrated handle, counter top in Dekton calacatta. Peninsula with counter top in steel Barazza scotch brite finish and tapered drain edge, supporting leg Minus in moka embossed lacquered aluminium, equipped with chopping board in Italian walnut, perforated chopping board and steel pan support. Snack counter Moon in solid bog oak and moka back painted glass fume. Stools Sophie in black elm with footrest in mat brown nickel, non-removable covering in leather Soft 8 visone. Modular system Infinity personalized Poliform with lighted aspiration unit, lighted spice holder unit and lighted phytostimulating unit, in steel and glass. Base units in solid bog oak with moka embossed lacquered integrated handle, counter top in steel Barazza scotch brite finish. Deep Shaker with structure in moka anodized aluminium, rame metal lacquered back. Glass tall units with moka anodized profile PR23 with integrated handle and line fume glass.





Nella pagina a destra: dettaglio gamba di sostegno Minus alluminio laccato goffrato moka. Sotto: dettaglio del piano della penisola in acciaio Barazza finitura scotch brite con vaso rastremato e top Dekton calacatta, ante laccato metallico rame.

Right page: close up of the supporting leg Minus in moka embossed lacquered aluminium. Below: close up of the peninsula counter top in steel Barazza scotch brite finish with tapered drain edge and counter top in Dekton calacatta, rame metal lacquered doors.

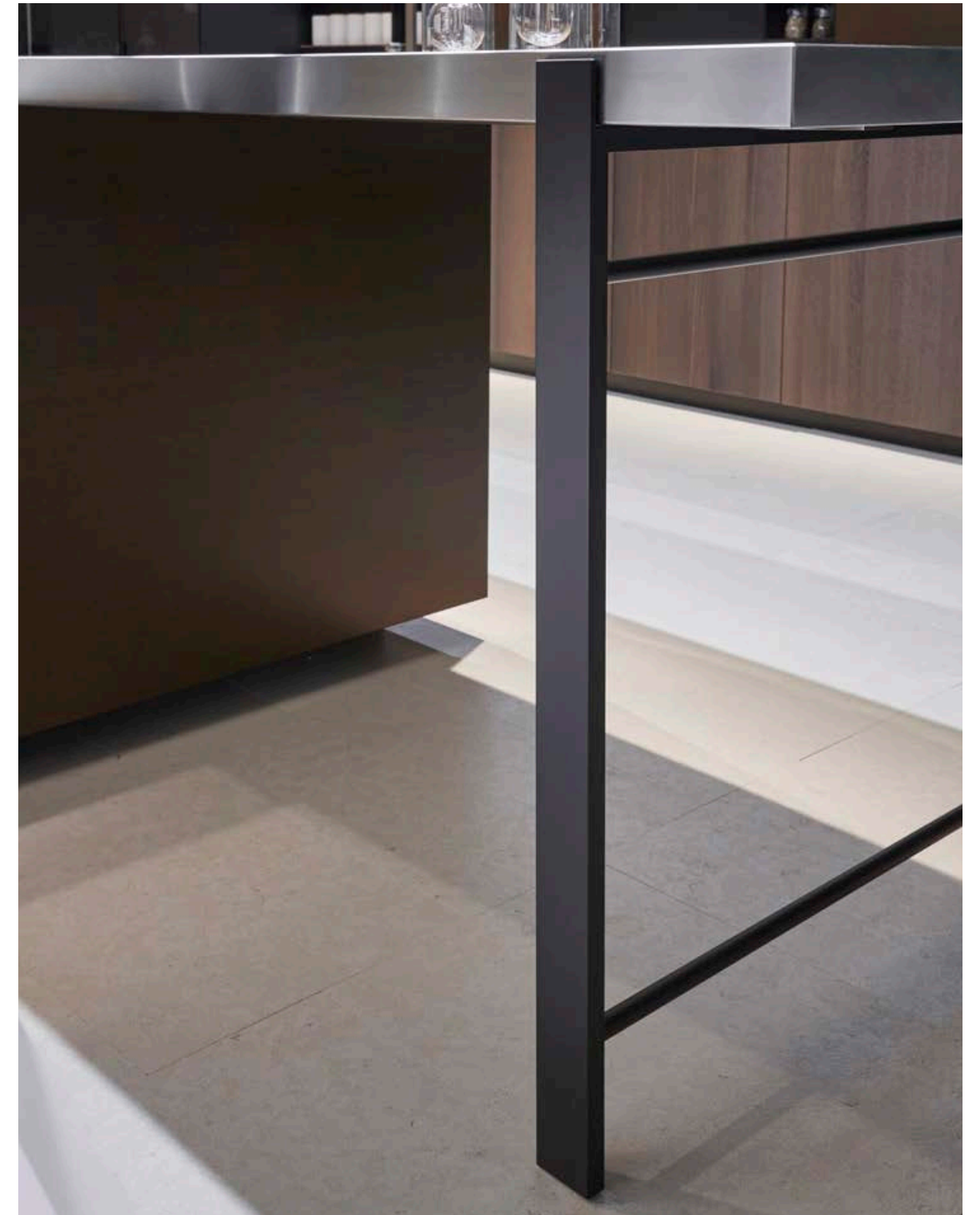





In questa pagina: dettaglio del cassetto interno verniciato brown con attrezzatura in noce canaletto e alluminio anodizzato moka.

This page: close up of the brown painted inner drawer with accessories in walnut canaletto and moka anodized aluminium.

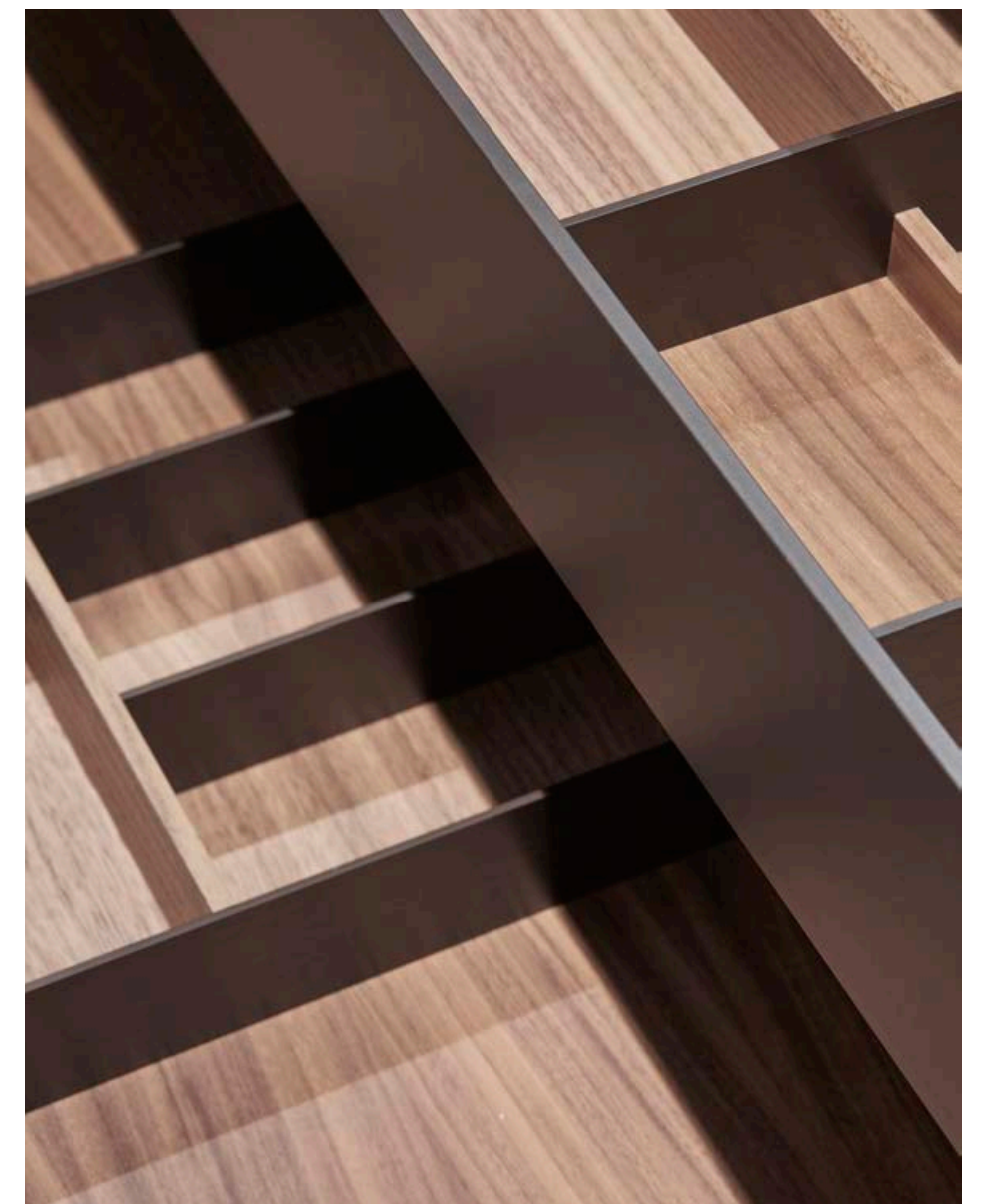







A destra: colonne vetrina profilo anodizzato moka PR23 con maniglia integrata e vetro line fumé. Basi massello rovere di palude con maniglia integrata Shape laccato goffrato moka, top acciaio Barazza finitura scotch brite. Deep Shaker, struttura alluminio anodizzato moka, schienale laccato metallico rame. Plafone smussato con cappa integrata personalizzata Poliform, con nuova profondità e luce integrata. Sotto: Deep Shaker con schienale laccato metallico rame, anta scorrevole profilo alluminio anodizzato moka e laccato metallico rame, tubo acciaio scotch brite.

Right: glass tall units with moka anodized PR23 profile with integrated handle and line fume glass. Base units in solid bog oak with integrated handle Shape embossed lacquered moka, counter top in steel Barazza scotch brite finish. Deep Shaker, structure in moka anodized aluminium, rame metal lacquered back. Tapered top shelf with integrated cooker hood personalized Poliform, with new depth and integrated light. Below: Deep Shaker with rame metallic lacquered back, sliding door with moka anodized profile and rame metal lacquer, bar in steel scotch brite.

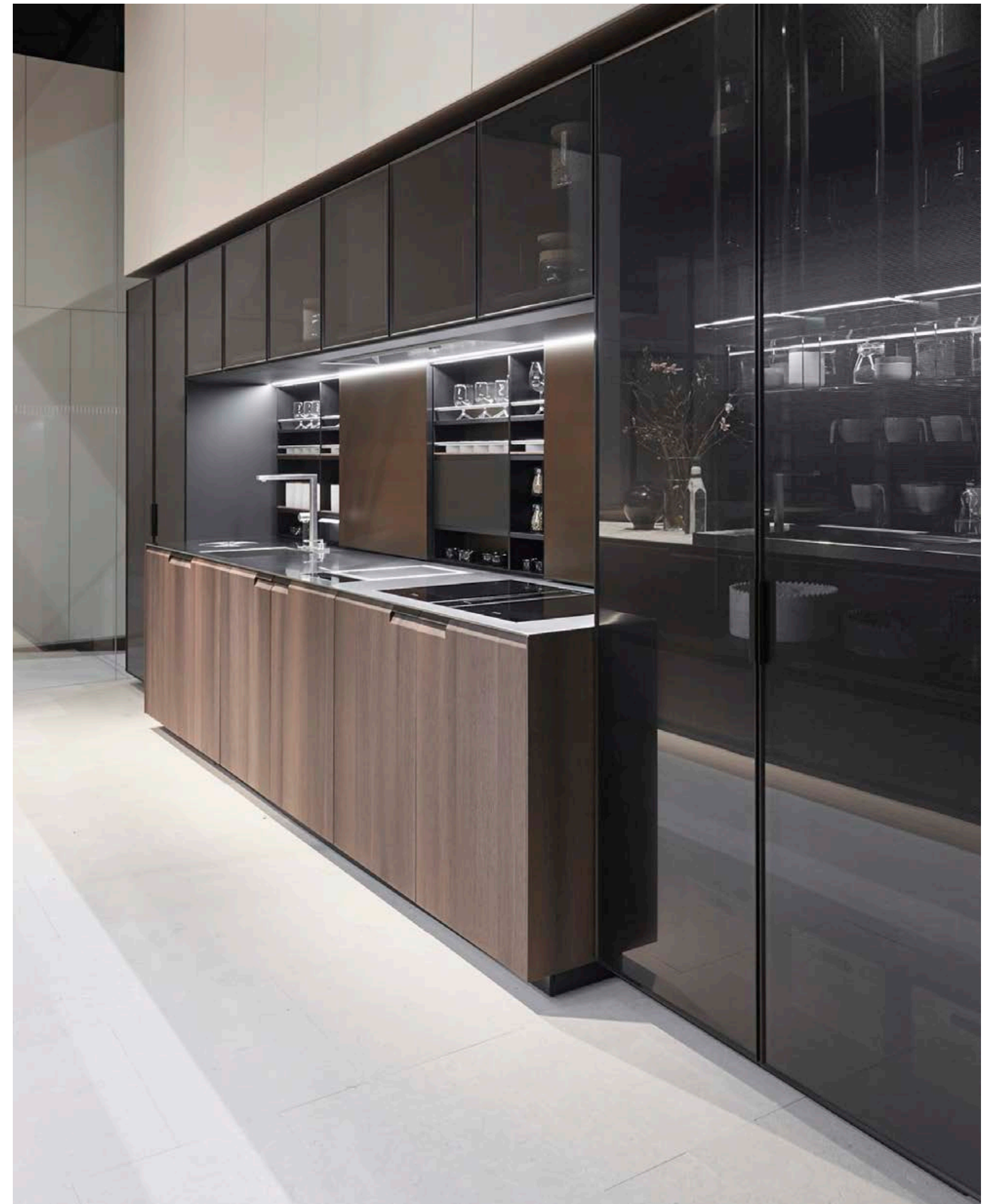









Nella pagina a sinistra: colonne con ante massello rovere di palude maniglia integrata Shape laccato goffrato moka. Colonne con ante a scomparsa con nuovo meccanismo, struttura nobilitato grigio lavagna attrezzate nella parte centrale con forni, ripiani e illuminazione a led integrata. Sotto: dettaglio della maniglia integrata verticale Shape laccato goffrato moka.

Left page: tall units with doors in solid bog oak, integrated Shape handle embossed lacquered moka. Tall units with retractable doors with new mechanism, structure melamine grigio lavagna accessorized central unit with ovens, shelves and led integrated lighting. Below: close up of the vertical integrated Shape handle embossed lacquered moka.









Nella pagina precedente e a destra colonne vetrina profilo anodizzato moka PR23 con maniglia integrata e vetro line fumé. Snack Moon massello rovere di palude e vetro fumé retroverniciato moka. Sgabelli Sophie olmo nero poggiapiedi in brown nickel opaco, rivestimento non sfoderabile in pelle Soft 8 visone.

Previous page and to the right, glass tall units with moka anodized PR23 profile with integrated handle and glass line fume. Snack counter Moon in solid bog oak and moka back painted fume glass. Stools Sophie in black elm, footrest in mat brown nickel, non-removable covering in leather soft 8 visone.





#### Basi isola

Struttura: nobilitato grigio lavagna.

Ante: laccato metallico rame.

Maniglia: integrata Shape, laccato goffrato moka.

Top: sp.6mm con telaio in alluminio di supporto, finitura Dekton calacatta; sp.60mm, con invaso rastremato, acciaio Barazza, finitura scotch brite.

Zoccolo: h.70mm laccato goffrato moka.

Minus, gamba di sostegno penisola: alluminio laccato goffrato moka.

Accessori: tagliere noce nazionale, tagliere forato e griglia poggia pentole in acciaio.

Cassetti ed estrattori: verniciato brown.

Portaposate: noce canaletto e alluminio anodizzato moka.

#### Snack Moon

Ø mm 1800, massello rovere di palude e vetro fumè retroverniciato moka.

#### Sgabelli Sophie alto

Emmanuel Gallina

Struttura: olmo nero, poggiapiedi brown nickel opaco.

Rivestimento: non sfoderabile in pelle Soft 8 visone.

#### Colonne

Struttura: nobilitato grigio lavagna.

Ante: massello rovere di palude.

Maniglia: integrata Shape, laccato goffrato moka.

Zoccolo: h.70mm laccato goffrato moka.

Cassetti ed estrattori interni: massello rovere di palude.

Portaposate: alluminio.

#### Colonne vetrina

Struttura: nobilitato grigio lavagna.

Ante: profilo PR23 anodizzato moka e vetro line fumè.

Zoccolo: h.70mm laccato goffrato moka.

#### Colonne parete

Struttura: nobilitato grigio lavagna.

Ante: profilo PR23 anodizzato moka e vetro line fumè.

Cassettiere interne: ante mod. Alea, laminato touch nero; maniglia profilo orizzontale Alea, alluminio anodizzato nero; top sp.20mm, laminato touch nero.

Cassetti ed estrattori: verniciato brown.

Portaposate: noce canaletto e alluminio anodizzato moka.

Zoccolo: h.70mm laccato goffrato moka.

#### Basi parete

Struttura: nobilitato grigio lavagna.

Ante: massello rovere di palude.

Maniglia: integrata Shape, laccato goffrato moka.

Top: sp.6mm con telaio in alluminio di supporto, acciaio Barazza, finitura scotch brite.

Zoccolo: h.70mm laccato goffrato moka.

Cassetti ed estrattori: verniciato brown.

Portaposate: noce canaletto e alluminio anodizzato moka.

#### Deep Shaker

Struttura: alluminio anodizzato moka, p. 160mm.

Schianale: laccato metallico rame.

Listello: acciaio scotch brite.

Anta scorrevole: profilo alluminio anodizzato moka e laccato metallico rame.

#### Elettrodomestici

Miele. Sistema modulare Infinity personalizzato Poliform, acciaio e vetro (modulo luminoso aspirante, modulo luminoso porta spezie, modulo luminoso fitostimolante).

#### Island base units

Struttura: lavagna grey melamine.

Doors: metal lacquer rame.

Handle: integrata Shape, embossed lacquered moka.

Worktop: th.6mm with aluminum support, Dekton calacatta th.60mm, chamfered drip edge, steel Barazza, scotch brite finishing.

Plinth: h.70mm, embossed lacquered moka.

Minus, penisola support leg: aluminum embossed lacquered moka.

Accessories: Italian walnut chopping board, drilled steel chopping board, steel table rack for pans.

Drawers and pullout-drawers: aluminum brown finishing.

Cutlery canteen: canaletto walnut with moka anodized aluminum.

#### Snack Moon

Ø mm 1800, solid bog oak and backpainted fumè glass.

#### High Sophie stools

Emmanuel Gallina

Structure: black elm, footrest in mat brown nickel.

Cover: non removable in Soft 8 visone leather.

#### Tall units

Struttura: lavagna grey melamine.

Doors: solid bog oak.

Handle: integrata Shape, embossed lacquered moka.

Plinth: h.70mm, embossed lacquered moka.

Inner drawers and pulloutbaskets: solid bog oak.

Cutlery canteen: anodized aluminum.

#### Glass tall units

Struttura: lavagna grey melamine.

Doors: profilo PR23 moka anodized with line fumè glass.

Plinth: h.70mm, embossed lacquered moka.

#### Tall units on the wall

Struttura: lavagna grey melamine.

Doors: profilo PR23 moka anodized with line fumè glass.

Internal drawer unit: fronts Alea, black touch laminate. Alea black anodized profiles, countertop th.20 black touch laminate.

Drawers and pullout-baskets: aluminum brown finishing.

Cutlery canteen: canaletto walnut with moka anodized aluminum.

Plinth: h.70mm, embossed lacquered moka.

#### Base units on the wall

Structure: lavagna grey melamine.

Doors: solid bog oak.

Handle: integrata Shape, embossed lacquered moka.

Worktop: th.6mm with aluminum support, steel Barazza, scotch brite finishing.

Plinth: h.70mm, embossed lacquered moka.

Drawers and pullout-baskets: aluminum brown finishing.

Cutlery canteen: canaletto walnut with moka anodized aluminum.

#### Deep Shaker

Struttura: moka anodized aluminum, d.160mm.

Backpanel: metal lacquer rame.

Pipe: steel scotch brite finishing.

Sliding door: moka anodized aluminum profile and metal lacquer rame.

#### Appliances

Miele. Customized Infinity modular system by Poliform, stainless steel and glass (lighting extractor module, lighting module spice rack and lighting module with phytoled lights).

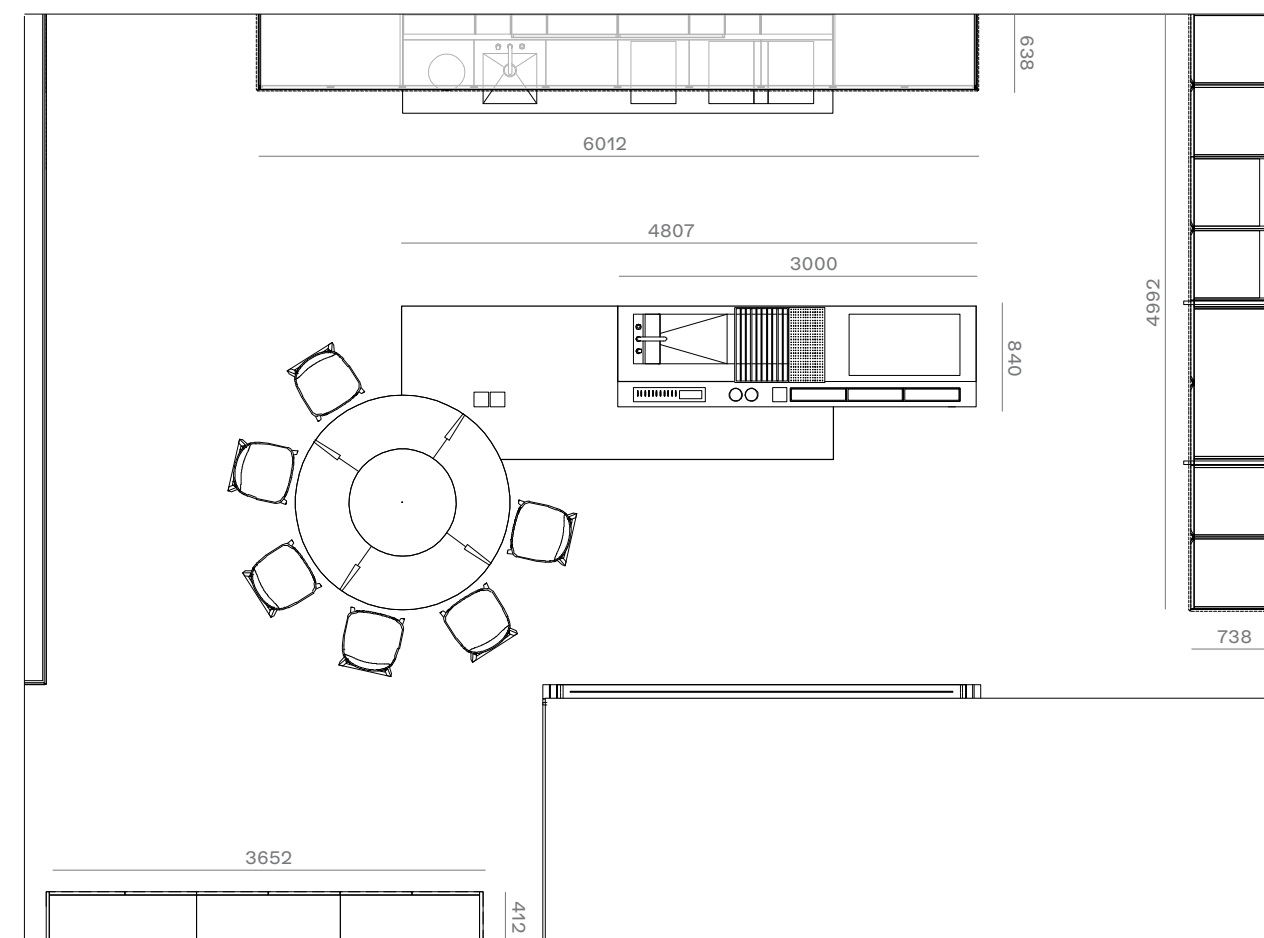



# SOPHIE



Sgabelli Sophie olmo nero poggiatesta in brown nickel opaco, rivestimento non sfoderabile in pelle Soft 8 visone.

Stools Sophie in black elm, footrest in mat brown nickel, non-removable covering in leather Soft 8 visone.







## SOPHIE

Design Emmanuel Gallina

### Finiture

Seduta e schienale imbottiti in poliuretano flessibile a quote differenziate e in poliuretano flessibile stampato, prerivestimento in fibra di poliestere. Rivestimento non sfoderabile in tessuto o pelle. Struttura in rovere spessart e olmo nero, poggiatesta in metallo verniciato brown nickel opaco con inserto in acciaio inox satinato.

### Finishings

Seat and back in flexible polyurethane in different densities and in flexible moulded polyurethane, pre-covering in polyester fibre. Final covering non-removable in fabric or leather. Structure in spessart oak and black elm, footrest in mat brown nickel painted metal with inlay in brushed stainless steel.

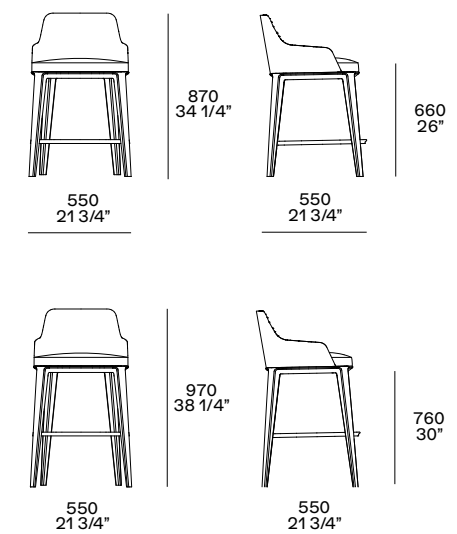



MATERIALS AND FINISHINGS

**Nobilitato strutture**  
**Structure melamine**



grigio perla  
perla grey



grigio lavagna  
lavagna grey

**Cassetti interni ed estrattori**  
**Internal drawers and pull-out baskets**



alluminio anodizzato  
anodized aluminium

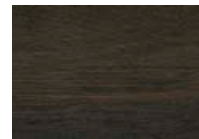

massello rovere di palude  
solid bog oak

**Attrezzature cassetti ed estrattori**  
**Drawers and pull-out baskets equipments**



laminato military touch  
laminated military touch

**Essenze**  
**Woods**



massello rovere di palude  
solid bog oak



noce nazionale  
italian walnut



massello rovere termico  
solid thermic oak

**Laccato metallico**  
**Metallic lacquered**



03 titanio



01 bronzo



02 rame

**Laccato goffrato e lucido**  
**Embossed and glossy lacquered**



92 vischio

**Vetro**  
**Glass**

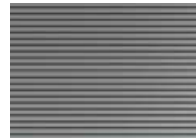

line fumé

**Ceramica texturizzata**  
**Texturized ceramic**



bianco



nero

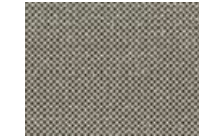

silver

**Laminati tuttocolore touch**  
**Tuttocolore laminate touch**



acciaio touch



alluminio touch



champagne touch

**Pietra**  
**Stone**



stone grey  
levigata / mat

**Dekton**  
**Dekton**



calacatta

**Marmo levigato**  
**Mat marble**



calacatta oro



emperador extra dark

**Marmo lucido**  
**Glossy marble**



calacatta oro

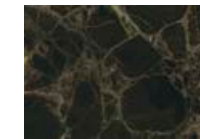

emperador extra dark

**Quarzite micropallinata**  
**Micro-blasted composite stone**



25 white va



26 beige va



27 storm va

**Quarzite lucida**  
**Glossy composite stone**



25 white va



26 beige va



27 storm va



**Poliform Spa**

via Montesanto 28  
Casella postale n. 1  
22044 Inverigo (CO) Italy  
t +39 031 6951  
f +39 031 699444  
info.poliform@poliform.it  
poliform.it

Poliform si riserva il diritto di apportare, senza preavviso, ogni modifica mirata al miglioramento funzionale e qualitativo dei propri prodotti. Testi e disegni presenti in questo stampato hanno scopo divulgativo: per ogni aspetto tecnico e dimensionale fare riferimento ai listini aziendali e relativi aggiornamenti. I campioni di colori e materiali hanno valore indicativo. Poliform reserves the rights at all time to apply modifications for the functional or qualitative improvement of its products. Texts and drawings present in this brochure have a divulgative purpose: for every technical and dimensional aspect please refer to the company's price lists and their relative updatings. The colour and material samples have an indicative value.

**Creative Direction**

Apartamento Studios

**Graphic Design**

Apartamento Studios

**Photography**

Silvia Orlandi

**Interiors Styling**

Poliform Lab

1st edition June 2018  
cod. K49/R1/2018



