

SOFAS COLLECTION
VOLUME ONE

Poliform

Poliform

Poliform presenta la collezione di imbottiti. Divani e poltrone che arredano i living più esclusivi e tutti gli ambienti della casa dove ci siano spazi da dedicare al comfort e al relax. Divani fissi o componibili pensati per diventare protagonisti della zona giorno e poltrone dai volumi avvolgenti. Lo stile è quello di Poliform – tra design eccellente, materiali pregiati e lavorazioni sartoriali.

Poliform presents the collection of upholstered furniture. Sofas and armchairs that decorate the most exclusive living areas and all the environments in the house where there are spaces to dedicate to comfort and relaxation. Fixed or modular sofas designed to become the protagonists of the day area and armchairs with enveloping volumes. The style is that of Poliform – between excellent design, fine materials, and tailored details.

COLLECTIONS

DIVANI
SOFAS

7

POLTRONE
ARMCHAIRS

215

SOFAS

Una collezione di divani che interpreta tutti gli stili del living contemporaneo: è quella che Jean-Marie Massaud, Carlo Colombo e Paola Navone hanno disegnato per Poliform. Sistemi che offrono la massima libertà compositiva, costituiti da elementi componibili che creano vere e proprie isole di comfort, ideali per il riposo e la convivialità. Proposte destinate a farsi notare nella zona giorno per il loro design esclusivo e i dettagli sartoriali.

A collection of sofas that interprets all the styles of contemporary living: it is the one that Jean-Marie Massaud, Carlo Colombo, and Paola Navone designed for Poliform. Systems that offer maximum compositional freedom, consisting of modular elements that create true islands of comfort, ideal for rest and conviviality. Offers destined to be noticed in the day area for their exclusive design and tailored details.

SOFAS

BELLPORT	11
MONDRIAN	49
BRISTOL	85
DUNE	121
SYDNEY	143
TRIBECA	159
SHANGAI	175
PARIS SEOUL	189
AIRPORT	203

BELLPORT



Bellport è la nuova collezione di imbottiti disegnata da Jean-Marie Massaud. Linee classiche e seduta profonda caratterizzano divani, poltrone, pouf e daybed, da combinare a piacere per creare il proprio comfort su misura. Con bracciolo basso o alto, Bellport è disponibile tesato o con fondo piega ed elegante bordo in seta, in sette colori.

Bellport is the new collection of upholstered furniture designed by Jean-Marie Massaud. Classic lines and deep seats characterize sofas, armchairs, poufs, and daybeds, to be combined as desired to create your own tailor-made comfort. With low or high armrest, Bellport is available with stretched or slipcover and an elegant edge in silk, in seven colours.







Qui e nelle pagine precedenti: divani Bellport rivestimento sfoderabile in pelle Nabuk 09 ruggine, cuscini con decoro e poggiatesta in pelle Nabuk 09 ruggine, cuscini in velluto Persia 1404 carbone, piedini con profilo brown nickel opaco. Tavolini Creek, quadrato con piano superiore in marmo sahara noir lucido, rettangolare con superiore in vetro fumé, piani inferiori in olmo nero e struttura brown nickel satinato. Tavolino Creek rotondo con piano superiore in marmo nero assoluto texture juta, piano inferiore in olmo nero e struttura brown nickel satinato. Pouf New York rivestimento sfoderabile in tessuto Norway 08 avorio e piedini brown nickel opaco.

This and previous pages: Bellport sofas with removable cover in leather Nabuk 09 ruggine, cushions with decoration and lower back cushion in leather Nabuk 09 ruggine, cushions in velvet Persia 1404 carbone, feet with profile in mat brown nickel. Creek coffee tables, square version with top in glossy marble sahara noir, rectangular version with top in fumé glass, lower shelves in black elm and mat brown nickel structure. Round Creek coffee table with top in marble nero assoluto texture juta, lower shelf in black elm and mat brown nickel structure. New York pouf with removable cover in fabric Norway 08 avorio and mat brown nickel feet.







Nella pagina precedente: divano Bellport con bracciolo basso, rivestimento sfoderabile in tessuto Kushiro 07 ferro, cuscini e poggiatesta in velluto Persia 1404 carbone, cuscini con decoro in tessuto Kushiro 07 ferro e piedini con profilo in champagne opaco. Qui e nella pagina successiva: divano Bellport con bracciolo alto, rivestimento sfoderabile in tessuto Kushiro 08 tortora, cuscini con decoro e poggiatesta in tessuto Kushiro 08 tortora, cuscini in velluto Persia 1404 carbone e piedini in brown nickel opaco.

Previous page: Bellport sofa with low armrest, removable cover in fabric Kushiro 07 ferro, cushions and lower back cushion in velvet Persia 1404 carbone, cushions with decoration in fabric Kushiro 07 ferro and feet with profile in mat champagne. This and next page: Bellport sofa with high armrest, removable cover in fabric Kushiro 08 tortora, cushions with decoration and lower back cushion in fabric Kushiro 08 tortora, cushions in velvet Persia 1404 carbone and feet in mat brown nickel.







Qui e nella pagina precedente: divani Bellport con bracciolo basso, rivestimento sfoderabile in tessuto Naxos 07 cemento, cuscino in tessuto Sendai 03 fango, pouf Bellport rivestimento sfoderabile in pelle Soft 13 carbone; divani e pouf con piedini champagne opaco. Poltrona Bellport rivestimento sfoderabile con fondopiega in tessuto Kitami 09 senape e bordura in seta colore nero, piedini in brown nickel opaco. Tavolini Creek, rettangolare e quadrato piani in marmo calacatta oro lucido e laccato lucido canapa, struttura champagne satinato; rotondi piani in vetro fumé e olmo nero, struttura in brown nickel satinato. Tavolino Soori in metallo finitura bronzo anticato. Sistema a giorno Wall System in rovere spessart, schienali laccato lucido canapa e luce led integrata. Tappeto Frame grey.

This and previous page: Bellport sofas with low armrest, removable cover in fabric Naxos 07 cemento, cushion in fabric Sendai 03 fango, pouf Bellport with removable cover in leather Soft 13 carbone; sofas and pouf with feet in mat champagne. Bellport armchair with removable slipcover in fabric Kitami 09 senape and border in silk colour nero, mat brown nickel feet. Creek coffee tables, rectangular and square version with top in glossy marble calacatta oro and canapa glossy lacquer, structure in brushed metal champagne: round version with top in glass fumé and black elm, structure in brushed brown nickel metal. Soori coffee table in metal with antique bronze finish. Wall System in spessart oak, canapa glossy lacquered backs and integrated led light. Carpet Frame grey.



In questa pagina: poltrona Bellport rivestimento sfoderabile con fondopiega in tessuto Naxos 08 antracite e bordura in seta colore nero, piedini in brown nickel opaco. Nella pagina successiva: divano Bellport con bracciolo basso, rivestimento sfoderabile con fondopiega in tessuto Naxos 32 bordeaux e bordura in seta colore acciaio, cuscini con decoro e poggiareni, piedini in brown nickel opaco.

This page: Bellport armchair with removable slipcover in fabric Naxos 08 antracite and border in silk colour nero, mat brown nickel feet. Next page: Bellport sofa with low armrest, removable slipcover in fabric Naxos 32 bordeaux and border in silk colour acciaio, cushions with decoration and lower back cushions, mat brown nickel feet.





In questa pagina: Bellport elemento XL rivestimento sfoderabile in pelle Nabuk 02 tortora, cuscini con decoro in tessuto Nayoro 02 sabbia e pelle Nabuk 02 tortora, piedini con profilo in brown nickel opaco.

This page: XL element Bellport with removable cover in leather Nabuk 02 tortora, cushions with decoration in fabric Nayoro 02 sabbia and leather Nabuk 02 tortora, feet with profile in mat brown nickel.



In questa pagina: Day Bed Bellport rivestimento sfoderabile in pelle Nabuk 08 prussia, cuscino a rullo con cinghia in cuoio 02 nero e piedini con profilo in brown nickel opaco. Tavolino Creek rotondo con piano superiore in marmo sahara noir lucido, piano inferiore in olmo nero e struttura brown nickel satinato. Sistema a giorno Quid con bacheche a giorno in olmo nero, ripiani in olmo nero e in vetro, boiserie centrale laccato metallico ottone, luce led integrata. Tavolino Soori in metallo finitura bronzo anticato.

This page: Bellport Day Bed with removable cover in leather Nabuk 08 prussia, roll cushion with belt in hide 02 nero and feet with profile in mat brown nickel. Round Creek coffee table with top in glossy marble sahara noir, lower shelf in black elm and mat brown nickel structure. Day system Quid with open display cases in black elm and mat brown nickel structure. Day system Quid with open display cases in black elm, shelves in black elm and in glass, middle wall panelling in metal lacquer ottone, integrated led light. Soori coffee table in metal with antique bronze finish.





Qui e nella pagina precedente: divani Bellport con bracciolo basso, rivestimento sfoderabile in pelle Nabuk 09 ruggine, piedini con profilo in brown nickel opaco. Tavolini Creek, quadrato con piano superiore in marmo sahara noir lucido, rettangolare con superiore in vetro fumé, piani inferiori in olmo nero e struttura brown nickel satinato. Tavolino Creek rotondo con piano superiore in marmo nero assoluto texture juta, piano inferiore in olmo nero e struttura brown nickel satinato.

This and previous page: Bellport sofas with low armrest, removable cover in leather Nabuk 09 ruggine, feet with profile in mat brown nickel. Creek coffee tables, square with top shelf in glossy marble sahara noir, rectangular with top shelf in fumé glass, lower shelves in black elm with mat brown nickel structure. Round Creek coffee table with top shelf in marble nero assoluto texture juta, lower shelf in black elm and mat brown nickel structure.







Qui e nella pagina precedente: divani Bellport con bracciolo basso, rivestimento sfoderabile in tessuto Olimpia 58 bianco, cuscino in tessuto Skyros 02 sabbia, cuscini e poggiatesta in tessuto Olimpia 58 bianco, piedini in champagne opaco.

This and previous page: Bellport sofas with low armrest, removable cover in fabric Olimpia 58 bianco, cushion in fabric Skyros 02 sabbia, lower back cushions in fabric Olimpia 58 bianco, feet in mat champagne.



BELLPORT

Design Jean-Marie Massaud, 2018

Struttura in legno e derivati. Cuscini schienale e seduta in poliuretano espanso a quote differenziate. Pre-rivestimento in tela cotone e piuma. Piedini fusione di alluminio verniciato, profilo estrusione di alluminio verniciato, verniciatura brown nickel opaco o champagne opaco. Rivestimento tessuto sfoderabile in tessuto o pelle. Rivestimento con fondopiega sfoderabile in tessuto con bordura in seta colori a campionario. Versione rivestimento con fondopiega solo per: poltrona, divani fissi, Day Bed, elemento XL centrostanza e pouf centrostanza.

Structure in wood and wood-by products. Backrest cushions and seat cushion in multi-density polyurethane foam. Pre-cover in cotton cloth and feather. Feet in painted aluminium casting, profile in painted aluminium extrusion, finish mat brown nickel or mat champagne. Stretched cover removable in fabric or leather. Slipcover removable in fabric with silk border in the colours as per sample book. Version with slipcover only for: armchair, fixed sofas, Day Bed, XL element and pouf for central use.

Bracciolo Arm



bracciolo basso
low arm



bracciolo alto
high arm

Piedini Feets



pedino e rivestimento tesato
feet and stretched cover



pedino con profilo e rivestimento tesato
feet with profile and stretched cover



pedino e rivestimento con fondopiega
feet and slipcover

Divano con bracciolo basso Sofa with low arm

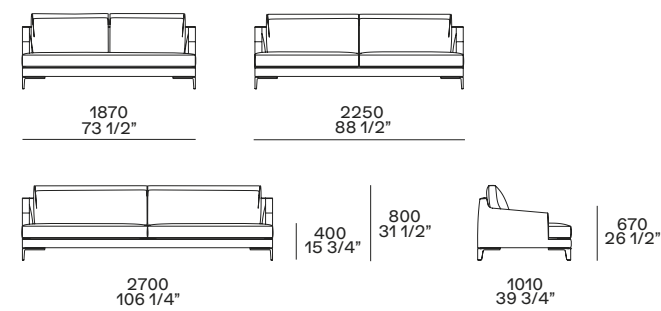

Day Bed centrostanza Freestanding Day Bed

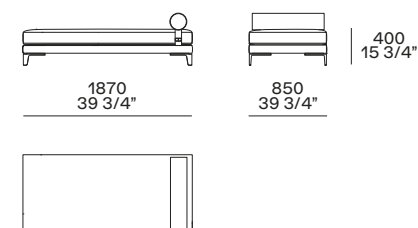

Con cuscino a rullo e cinghia in cuoio
With roll cushion and hide band

Elemento XL centrostanza Freestanding XL element

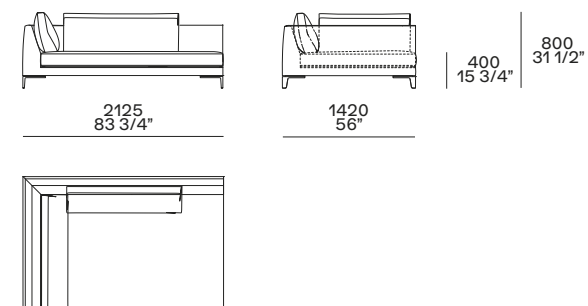

Poltrona con bracciolo basso Armchair with low arm

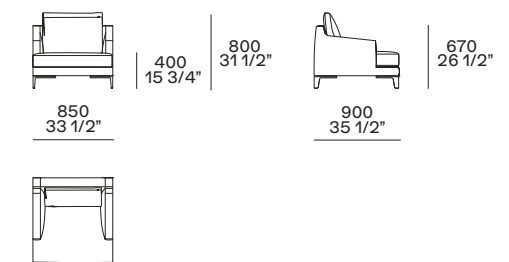

Pouf centrostanza Freestanding pouf

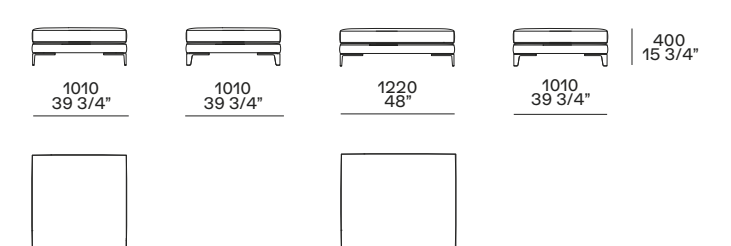

Chaise longue centrostanza Freestanding chaise longue

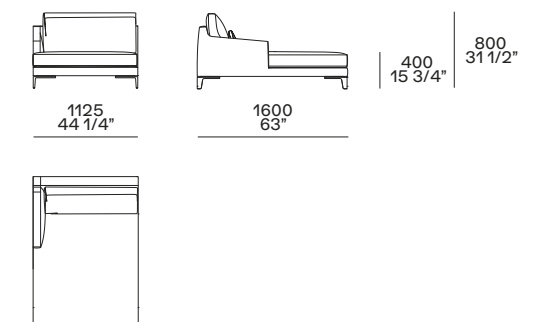

Poggiareni profondità 80 mm Lower back cushion depth 80 mm

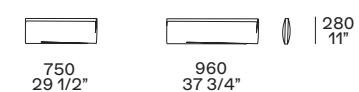

larghezza 750 abbinabile agli schienali I 810 - 1000
larghezza 960 abbinabile allo schienale I 1220
width 750 for backs width 810 - 1000
width 960 for backs width 1220

Cuscini Cushions



con decoro
with decoration

per elemento XL
for XL element

Terminale sx-dx con bracciolo basso
Lt-rt end unit with low arm

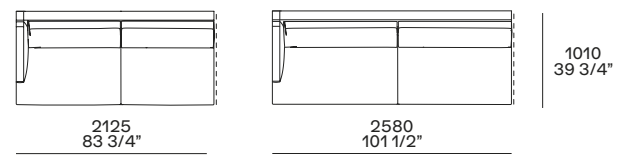

Terminale penisola sx-dx con bracciolo basso
Lt-rt peninsula end unit with low arm

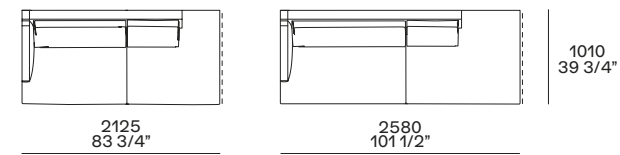

Terminale sx-dx con bracciolo alto
Lt-rt end unit with high arm

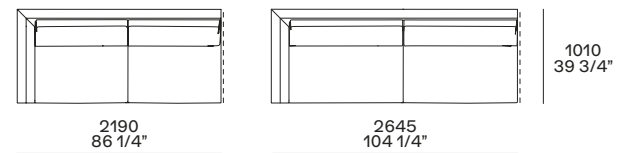

Terminale penisola sx-dx con bracciolo alto
Lt-rt peninsula end unit with high arm

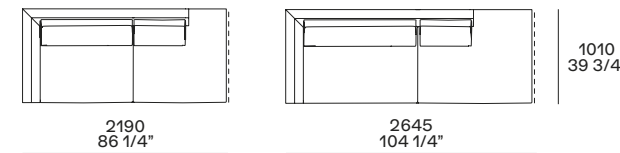

Centrale penisola sx-dx
Lt-rt peninsula central unit

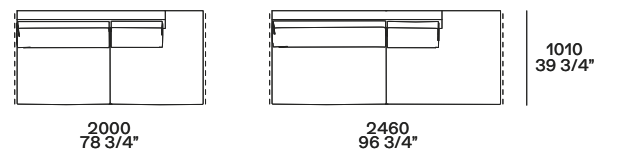

Centrale
Central unit

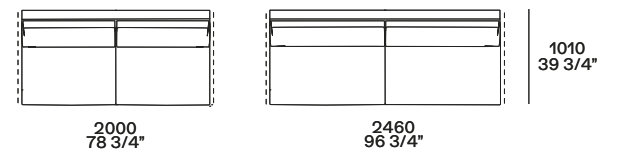

Pouf centrale
Central unit pouf

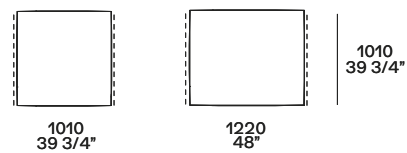

Angolo sx-dx
Lt-rt corner unit

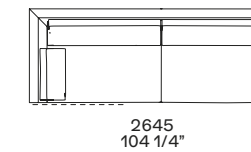
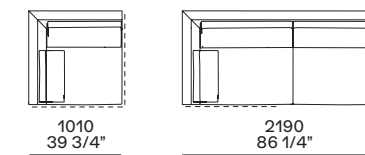

Angolo penisola sx-dx
Lt-rt peninsula corner unit

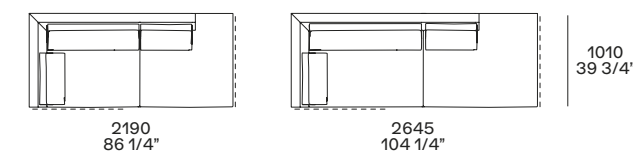

Chaise longue terminale sx-dx con bracciolo basso
Lt-rt end unit chaise longue with low arm

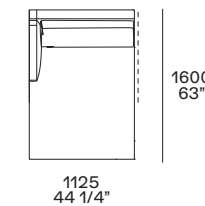

Elemento XL
XL element

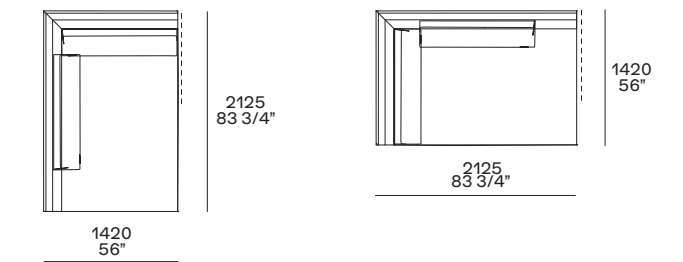

uso chaise longue sx-dx
 chaise longue lt-rt

uso terminale sx-dx
 end unit lt-rt

Terminale angolo sx-dx con bracciolo basso
Lt-rt corner end unit with low arm

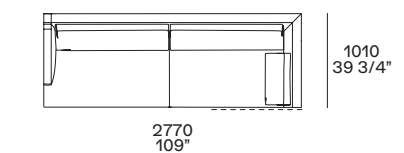

Pouf terminale sx-dx
Lt-rt end unit pouf

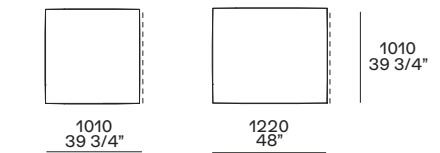

MONDRIAN

Un design essenziale, un'immagine grafica e moderna dalla forte valenza architettonica. Mondrian è un sistema pensato per offrire la massima libertà compositiva. I caratteristici piedini sottili in metallo sostengono una struttura lineare che sembra sospesa. Due le profondità di seduta disponibili e quattro le dimensioni dei braccioli, da arricchire con schienale in legno e mensole, o con il tavolino in essenza. Un progetto completo che interpreta con personalità il living contemporaneo.

A minimalistic design, a graphic and modern image with a strong architectural component. Mondrian is a system designed to offer maximum compositional freedom. The characteristic thin metal feet support a linear structure that seems suspended. Two seat depths available and armrests in four sizes, to be enriched with wooden backrest and shelves, or with the wooden coffee table. A complete project that interprets the contemporary living space with personality.







Qui e nelle pagine precedenti: divano Mondrian rivestimento sfoderabile in tessuto Kitami 11 oceano, cuscini in tessuto Sendai 05 navy e Naxos 16 sabbia, tavolino integrato in olmo nero e piedini in brown nickel opaco. Tavolino Bristol piano in marmo calacatta oro levigato e in olmo nero, inserti e piedini in brown nickel opaco. Tavolino Paris Seoul in cuoio 02 nero e interno struttura in brown nickel opaco. Tavolini Mondrian struttura in brown nickel opaco e piano laccato lucido roccia. Poltrone Stanford esterno in cuoio 26 invecchiato, interno in pelle Soft 04 cognac, basamento girevole in brown nickel lucido. Panca Home Hotel struttura in olmo nero e seduta rivestita in cordatura di pelle testa di moro. Tappeto Plain tortora.

This and previous pages: Mondrian sofa with removable cover in fabric Kitami 11 oceano, cushions in fabric Sendai 05 navy and Naxos 16 sabbia, integrated coffee table in black elm and mat brown nickel feet. Bristol coffee table with top in mat marble calacatta oro and in black elm, inlays and feet in mat brown nickel. Paris Seoul coffee table in hide 02 nero and inner structure in mat brown nickel. Mondrian coffee tables with mat brown nickel structure and roccia glossy lacquered top. Stanford armchairs with outer cover in hide 26 invecchiato, inner cover in leather Soft 04 cognac, and swivel base in glossy brown nickel. Home Hotel bench with black elm structure and seat covered in stringed dark brown leather. Carpet Plain tortora.







Qui e nella pagina precedente: divano Mondrian ad angolo, lato pouf terminale nella profondità 1250 mm. Rivestimento sfoderabile in tessuto Kitami 07 roccia, cuscini in velluto Persia 1404 carbone e tessuto Kitami 07 roccia con inserto a croce Persia carbone, tavolino integrato in olmo nero e piedini in brown nickel lucido. A sinistra: dettaglio del cuscino schienale con rullo. Sotto: dettaglio del poggiatesta con struttura rivestita in cuoio 03 grigio scuro. Nella pagina successiva: divano Mondrian rivestimento sfoderabile in pelle Soft 10 prugna, cuscini in velluto Persia 2006 prugna e tessuto Olimpia 112 prugna, tavolino integrato in olmo nero e piedini in brown nickel opaco.

This and previous page: Mondrian corner sofa, side with pouf as end unit d. 1250 mm. Removable cover in fabric Kitami 07 roccia, cushions in velvet Persia 1404 carbone and fabric Kitami 07 roccia with cross insert in Persia carbone, integrated coffee table in black elm and glossy brown nickel feet. Left: close up of the backrest cushion with roll. Below: close up of the headrest with structure covered in hide 03 grigio scuro. Next page: Mondrian sofa covered in removable leather Soft 10 prugna, cushions in velvet Persia 2006 prugna and fabric Olimpia 112 prugna, integrated coffee table in black elm and mat brown nickel feet.





In questa pagina: divano Mondrian in tessuto sfoderabile Olimpia 11 polvere, tavolino integrato e schienale in legno con mensole in olmo nero. Pouf Mondrian in velluto sfoderabile Persia 1404 carbone. Tavolini Mondrian struttura in fusione di bronzo lucidata oro, piani in marmo noir saint laurent lucido e laccato lucido caramello. Poltrone Stanford esterno in cuoio 26 invecchiato, interno in pelle Soft 04 cognac, basamento girevole in brown nickel lucido. Tappeto Frame grey.

This page: Mondrian sofa in removable fabric Olimpia 11 polvere, integrated coffee table and backrest in wood with shelves in black elm. Mondrian pouf in removable velvet Persia 1404 carbone. Mondrian coffee tables with structure in gold polishes bronze casting, tops in glossy marble noir saint laurent and caramello glossy lacquer. Stanford armchairs with outer cover in hide 26 invecchiato, inner cover in leather Soft 04 cognac, and swivel base in glossy brown nickel. Carpet Frame grey.





Nella pagina precedente: divano Mondrian in pelle sfoderabile Soft 10 prugna, cuscini in tessuto Olimpia 112 prugna, tavolino integrato in olmo nero e piedini in brown nickel opaco. Tavolini Mondrian con struttura in brown nickel lucido e piani in olmo nero e laccato lucido ocra; con struttura in fusione di bronzo lucidata oro e piano in marmo calacatta oro levigato. Poltrone Marlon in tessuto sfoderabile Sparta 16 ferro, gambe in olmo nero. In questa pagina: Mondrian chaise longue rivestimento sfoderabile in pelle Soft 02 mastice, cuscino in tessuto Naxos 16 sabbia e in pelle Soft 02 mastice, tavolino integrato in rovere spessart e cassetto opzionale con maniglia in cuoio 02 nero, piedini in brown nickel opaco.

Previous page: Mondrian sofa in removable leather Soft 10 prugna, cushions in fabric Olimpia 112 prugna, integrated coffee table in black elm and mat brown nickel feet. Mondrian coffee tables with structure in glossy brown nickel and tops in black elm and in ocra glossy lacquer; with structure in gold polished bronze casting and top in mat marble calacatta oro. Marlon armchairs in removable fabric Sparta 16 ferro, legs in black elm. This page: Mondrian chaise longue with removable cover in leather Soft 02 mastice, cushion in fabric Naxos 16 sabbia and in leather Soft 02 mastice, integrated coffee table in spessart oak and optional drawer with handle 02 nero, feet in mat brown nickel.







Nella pagina precedente: divano Mondrian rivestimento sfoderabile in tessuto Naxos 32 bordeaux, poggiatesta con struttura rivestita in cuoio 15 prugna e piedini in brown nickel opaco. In questa pagina: pouf Mondrian rivestimento sfoderabile in pelle Nabuk 04 moka, tavolino integrato in olmo nero e piedini in brown nickel lucido.

Previous page: Mondrian sofa with removable cover in fabric Naxos 32 bordeaux, headrest cushion with structure covered in hide 15 prugna and mat brown nickel feet. This page: Mondrian pouf with removable cover in leather Nabuk 04 moka, integrated coffee table in black elm and glossy brown nickel feet.





In questa pagina: divano Mondrian in tessuto sfoderabile Sparta 18 panna, cuscini in tessuto Sparta 15 ardesia e 18 panna con inserto a croce Persia carbone, piedini in brown nickel lucido. Tavolini e consolle Mondrian con struttura in fusione di bronzo lucidata oro e piani in marmo noir saint laurent lucido e laccato lucido muschio. Poltrone Mad Joker rivestimento non sfoderabile, esterno in pelle Nabuk 02 tortora e interno tessuto Zante 17 melanzana, basamento girevole in brown nickel lucido. Tappeto Soft.

This page: Mondrian sofa in removable fabric Sparta 18 panna, cushions in fabric Sparta 15 ardesia and 18 panna with cross insert in Persia carbone, glossy brown nickel feet. Mondrian coffee tables and console with structure in gold polished bronze casting and top in glossy marble noir saint laurent and muschio glossy lacquer. Mad Joker armchairs with non-removable cover, outer cover in leather Nabuk 02 tortora and inner cover in fabric Zante 17 melanzana, swivel base in glossy brown nickel. Carpet Soft.



MONDRIAN

Design Jean-Marie Massaud, 2016

Struttura in poliuretano flessibile stampato, prerivestimento in fibra di poliestere accoppiata. Schienale in legno con mensola e tavolino integrato in legno e derivati, impiallacciati in olmo nero o rovere spessart. Cuscino seduta in poliuretano flessibile sagomato a quote differenziate, prerivestimento in tela cotone e piuma con parti in fibra di poliestere accoppiata. Cuscino schienale con rullo in poliuretano flessibile sagomato a quote differenziate, prerivestimento parti in tela cotone con interni in piuma e parti in fibra di poliestere accoppiata. Kit cuscini schienale: coppia di cuscini utilizzabili in alternativa al cuscino schienale con rullo. 500 x 500 mm parti in tela cotone e piuma, 550 x 550 mm parti in tela cotone e piuma con interno in poliuretano flessibile sagomato. Poggiatesta opzionale in poliuretano flessibile sagomato con prerivestimento ovatta di poliestere accoppiata, struttura in metallo rivestito in cuoio colori. Piedini in fusione di alluminio verniciato brown nickel opaco o lucido. Rivestimento finale sfoderabile in tessuto o pelle.

Structure in flexible moulded polyurethane, pre-cover in polyester fibre. Back in wood with integrated shelf and coffee table in wood and wood-by products, veneered in black elm or spessart oak. Seat cushion in flexible shaped multi-density polyurethane, pre-cover in cotton cloth and feather with parts in polyester fibre. Backrest cushion with roll in flexible shaped multi-density polyurethane, pre-cover with parts in cotton cloth with feather inside and parts in polyester fibre. Backrest cushions-kit: pair of cushions, which can be used as an alternative to the backrest cushion with roll. 500 x 500 mm with parts in cotton cloth and feather, 550 x 550 mm with parts in cotton cloth and feather with flexible shaped polyurethane inside. Optional headrest in flexible shaped polyurethane with pre-cover in polyester wadding, structure in metal covered in hide in the available colours. Feet in aluminium-casting painted mat or glossy brown nickel. Final removable cover in fabric or leather.

Schienale tessuto o pelle Fabric or leather back



bracciolo 75
arm 75



bracciolo 200
arm 200



bracciolo 400
arm 400



tavolino 400
coffee table 400

Schienale legno con mensole Wooden back with shelves



bracciolo 75
arm 75



bracciolo 200
arm 200



bracciolo 400
arm 400



tavolino 400
coffee table 400

Profondità 950 Depth 950 - 37 1/2"

Bracciolo 75
Arm 75

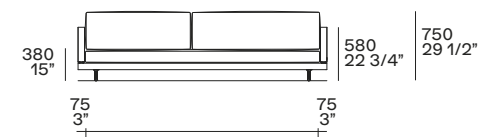

Schienale tessuto o pelle
Fabric or leather back

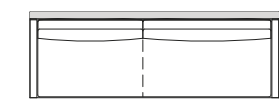

Schienale legno con mensole
Wooden back with shelves

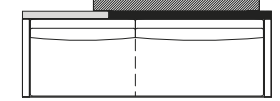

Bracciolo 200
Arm 200

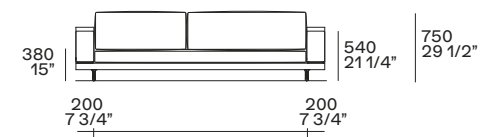

Schienale tessuto o pelle
Fabric or leather back

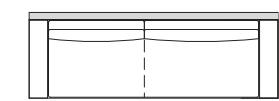

Schienale legno con mensole
Wooden back with shelves

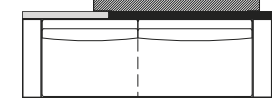

Bracciolo 400
Arm 400

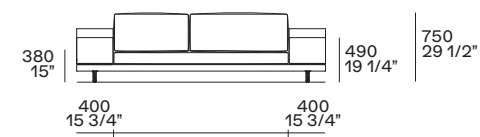

Schienale tessuto o pelle
Fabric or leather back

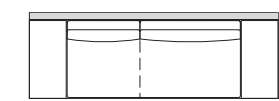

Schienale legno con mensole
Wooden back with shelves

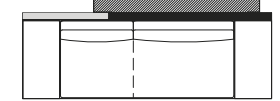

Tavolino 400 con cassetto opzionale
Coffee table 400 with optional drawer

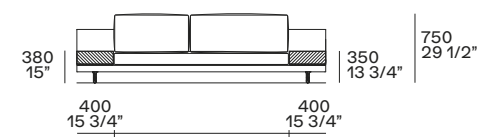

Schienale tessuto o pelle
Fabric or leather back

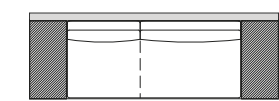

Schienale legno con mensole
Wooden back with shelves

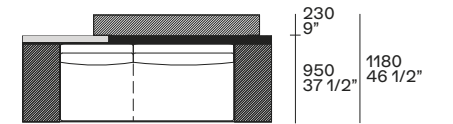

Profondità 1250 Depth 1250 - 49 1/4"

Bracciolo 200
Arm 200

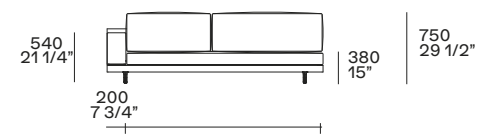

Schienale tessuto o pelle
Fabric or leather back

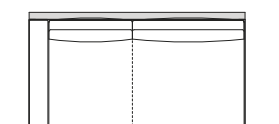

Tavolino 400 con cassetto
Coffee table 400 with drawer

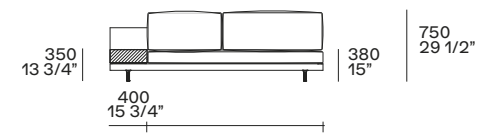

Schienale tessuto o pelle
Fabric or leather back

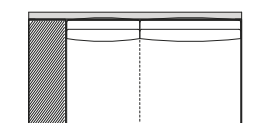

1250
49 1/4"

Profondità 950
Depth 950 - 37 1/2"

Divani fissi
Fixed sofas

bracciolo 75
arm 75

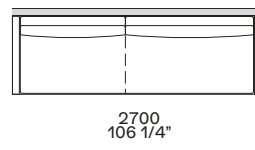
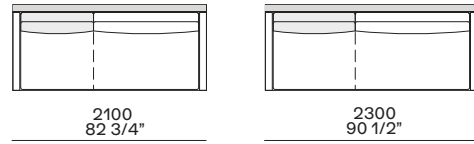

bracciolo 200
arm 200

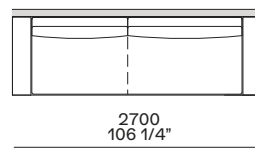
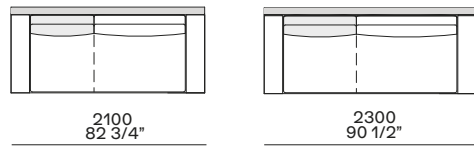

bracciolo 200 e 400
arm 200 and 400

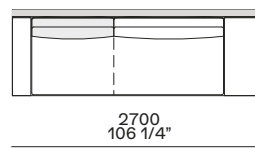
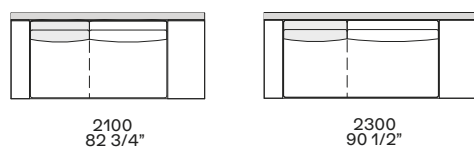

bracciolo 400
arm 400

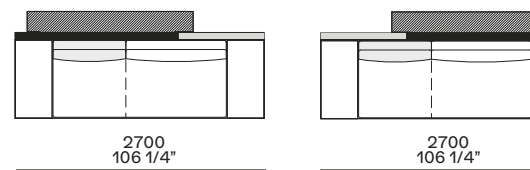
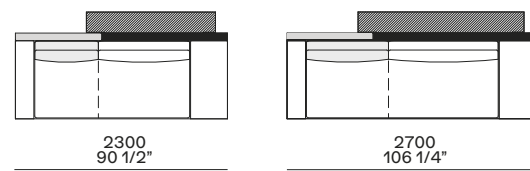
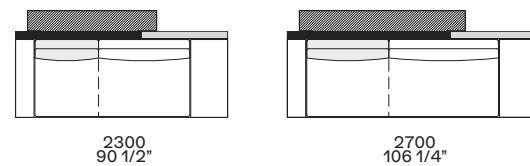
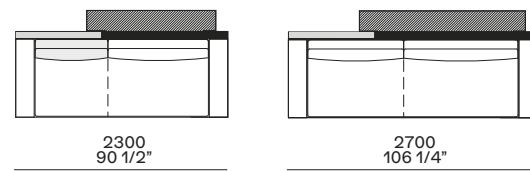
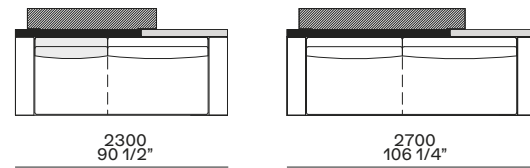
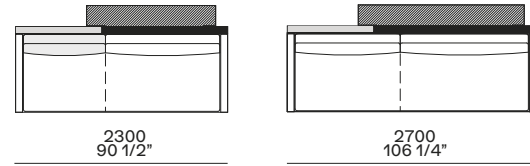
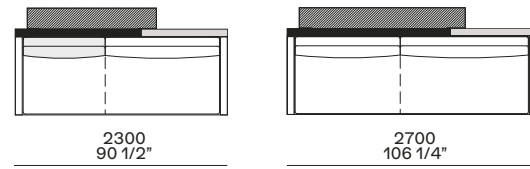
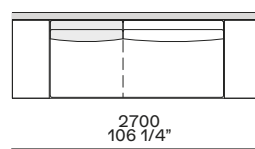

Profondità 950
Depth 950 - 37 1/2"

Divani fissi
Fixed sofas

bracciolo 200 e tavolino 400
arm 200 and coffee table 400

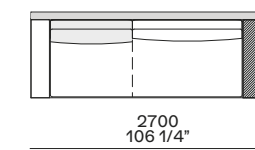
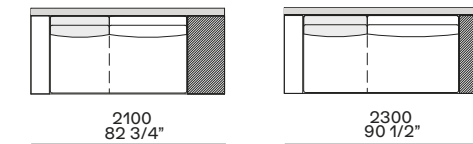

bracciolo 400 e tavolino 400
arm 200 and coffee table 400

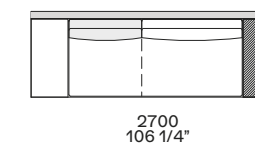

tavolini 400
coffee tables 400

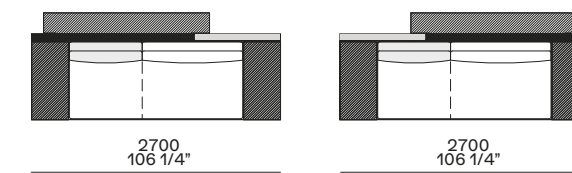
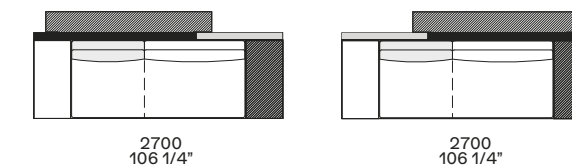
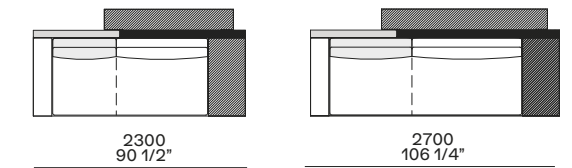
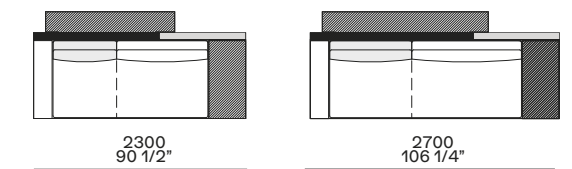
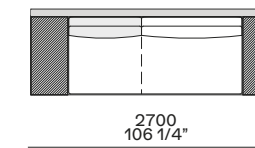

Cuscini
Cushions

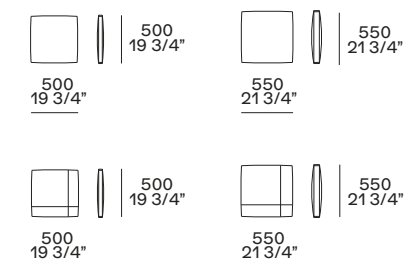

Lavorazione a croce in tessuto Persia
Cross insert in fabric Persia

Poggiatesta
Headrest

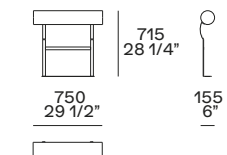

Profondità 950
Depth 950 - 37 1/2"

Terminale sx-dx
Lt-rt end unit

bracciolo 75
arm 75

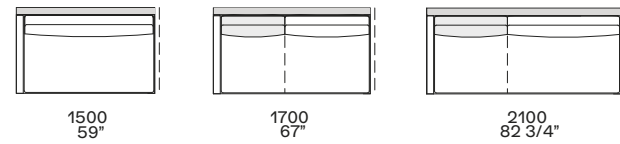

bracciolo 200
arm 200

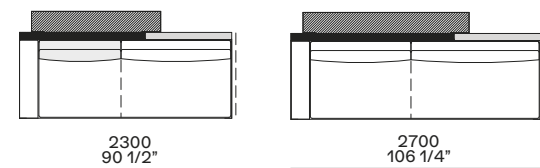
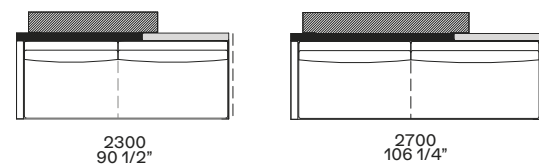
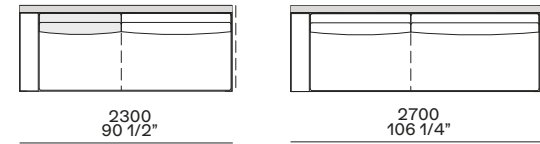
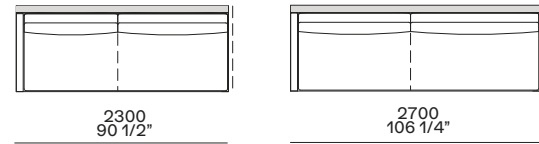
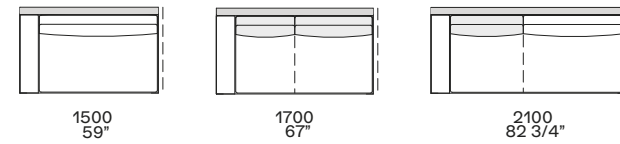

bracciolo 75 e tavolino 400
arm 75 and coffee table 400

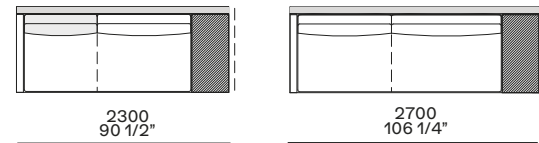

bracciolo 200 e tavolino 400
arm 200 and coffee table 400

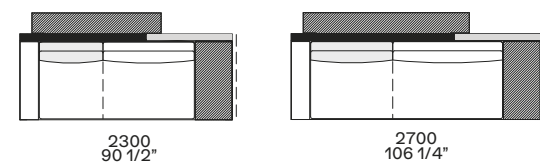
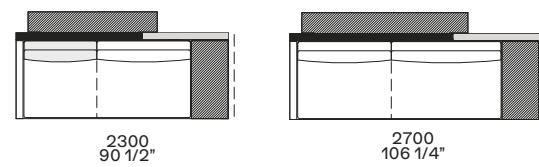
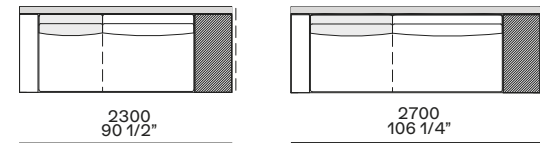

bracciolo 400
arm 400

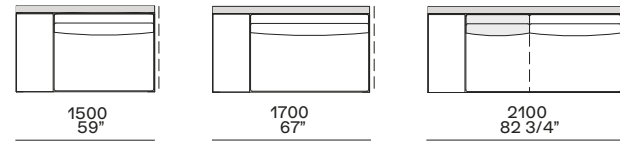

tavolino 400
coffee table 400

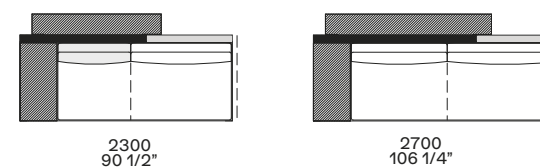
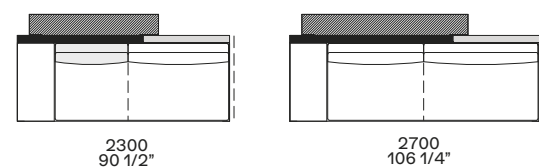
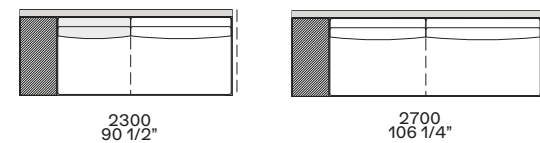
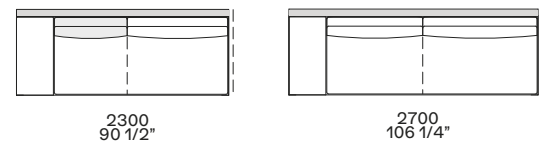
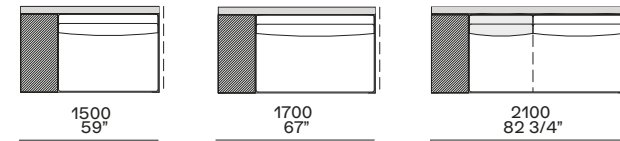

Profondità 950
Depth 950 - 37 1/2"

Terminale sx-dx
Lt-rt end unit

bracciolo 400 e tavolino 400
arm 400 and coffee table 400

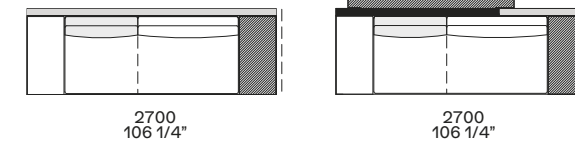

tavolini 400
coffee tables 400

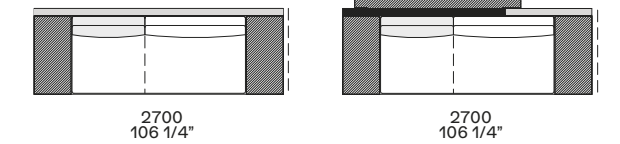

Centrale
Central unit

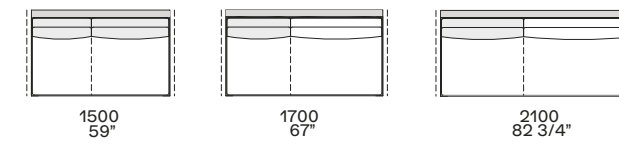

tavolino 400
coffee table 400

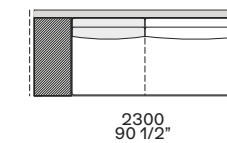
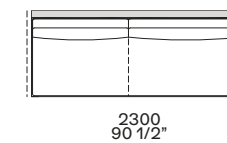
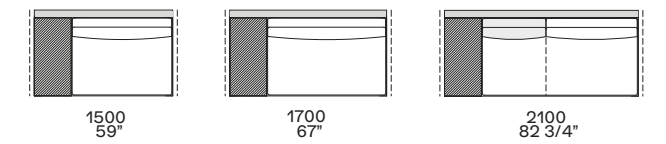

Terminale penisola sx-dx
Lt-rt peninsula end unit

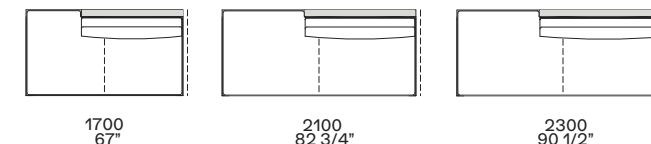

tavolino 400
coffee table 400

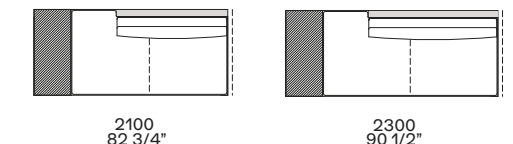

Chaise longue
Chaise longue

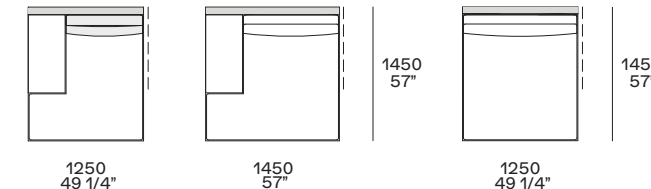

Pouf
Pouf

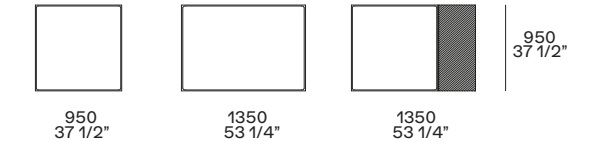

uso centrostanza o terminale
freestanding or end unit

uso centrostanza,
terminale o centrale
freestanding, end unit
or central unit

uso centrostanza, terminale, angolo o centrale
freestanding, end unit, corner or central unit

NB
I cuscini schienale, evidenziati in grigio possono essere sostituiti con un kit cuscini.

The seat cushions indicated in grey can be replaced by a loose cushions kit.

Profondità 950
Depth 950 - 37 1/2"

Angolo sx-dx con cuscini schienale
Lt-rt corner unit with backrest cushions

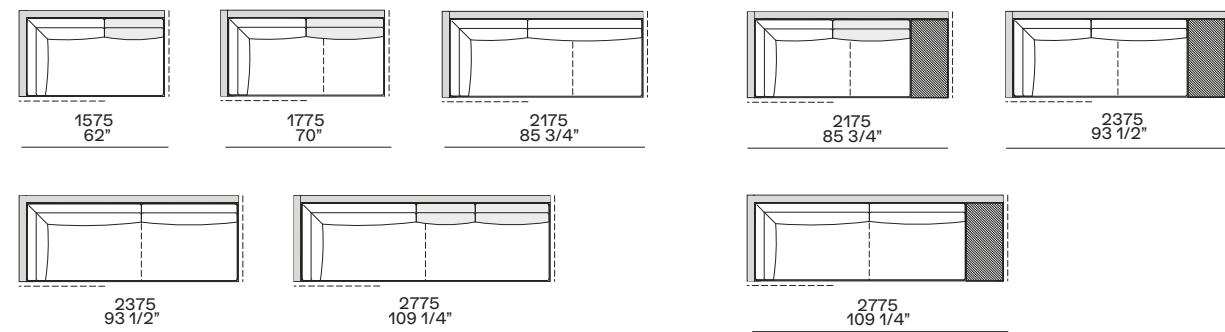

Terminale angolo sx-dx con cuscini schienale
Lt-rt corner end unit with backrest cushions

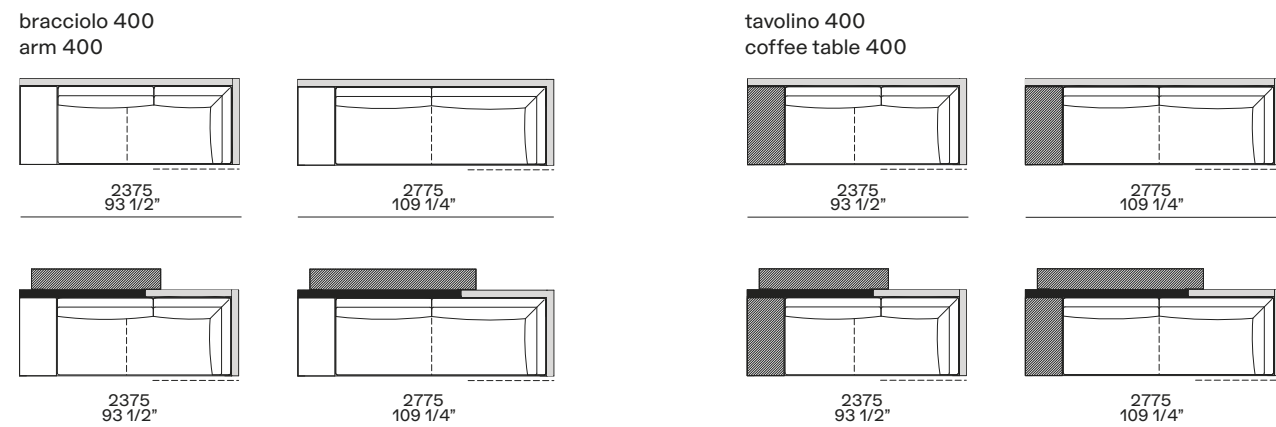
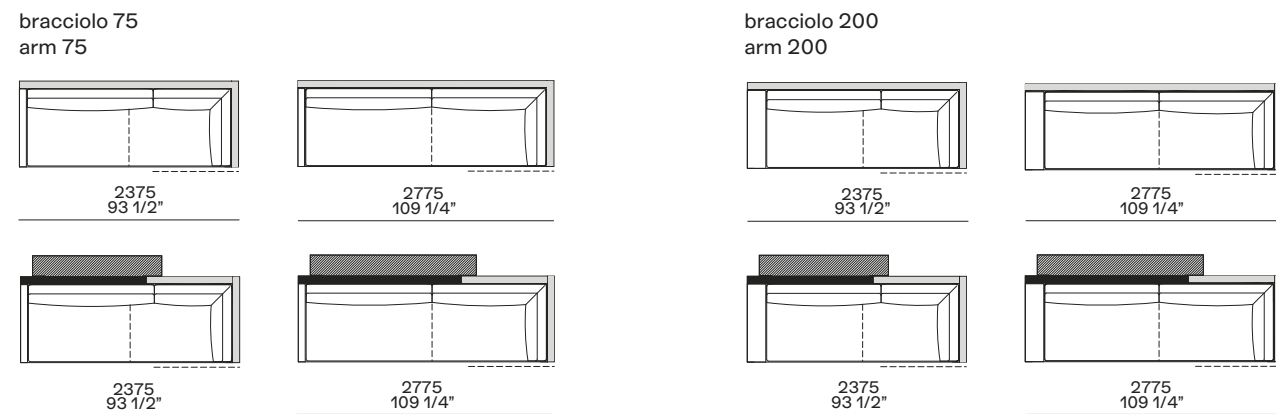

Penisola, angolo penisola o divano chaise longue sx-dx con cuscini schienale
Lt-rt peninsula, corner peninsula or chaise longue sofa with backrest cushions

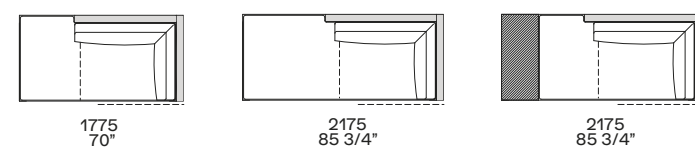

NB
 I cuscini schienale, evidenziati in grigio possono essere sostituiti con un kit cuscini.

The seat cushions indicated in grey can be replaced by a loose cushions kit.

Profondità 950
Depth 950 - 37 1/2"

Angolo sx-dx con kit cuscini
Lt-rt corner unit with kit cushions

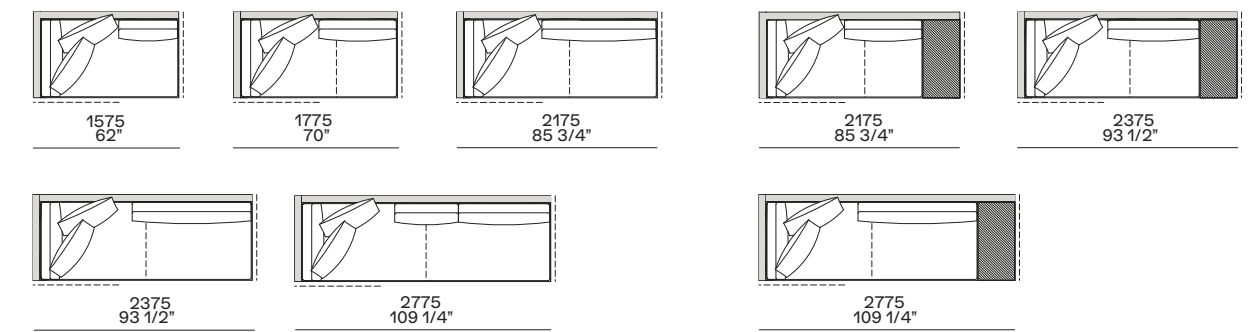

Terminale angolo sx-dx con kit cuscini
Lt-rt corner end unit with kit cushions

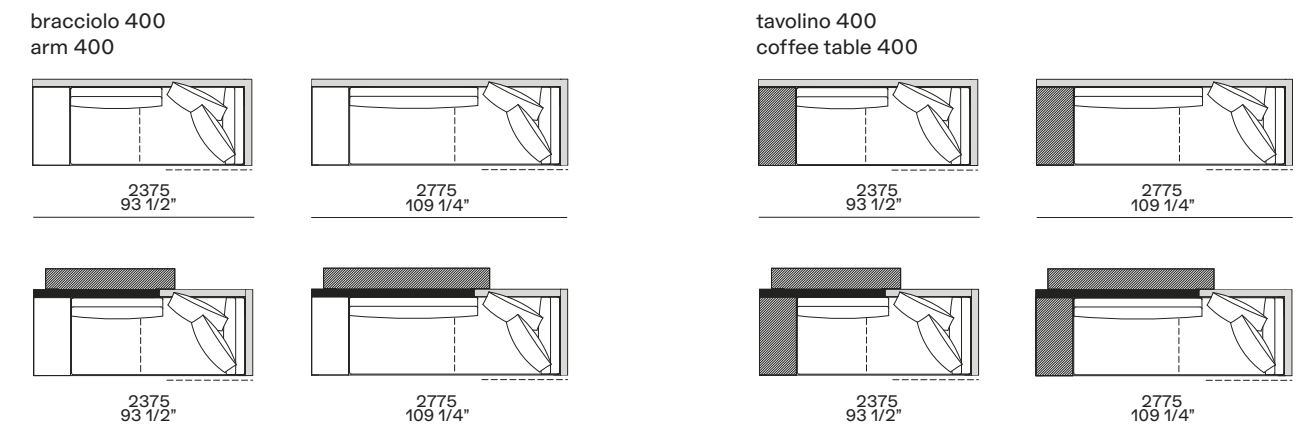
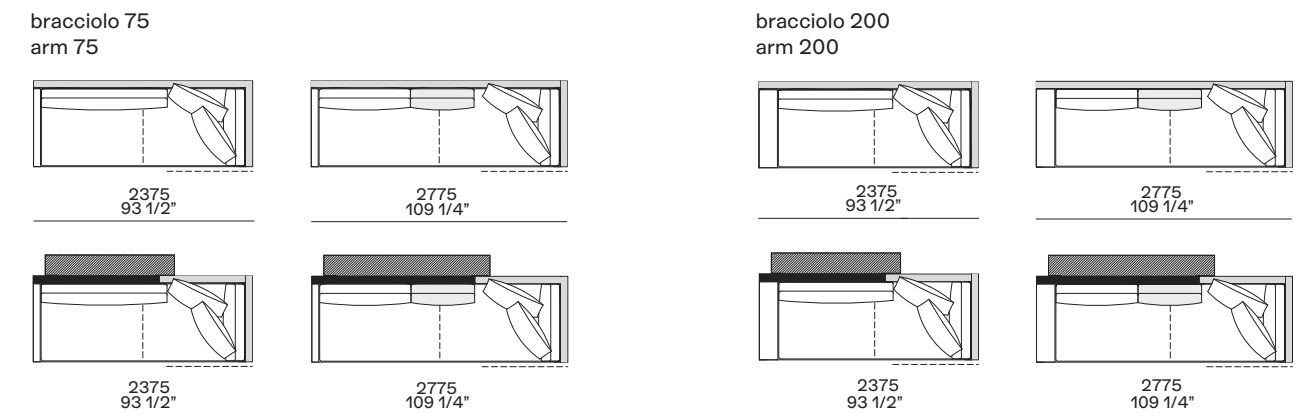

Penisola, angolo penisola o divano chaise longue sx-dx con kit cuscini schienale
Lt-rt peninsula, corner peninsula or chaise longue sofa with kit cushions

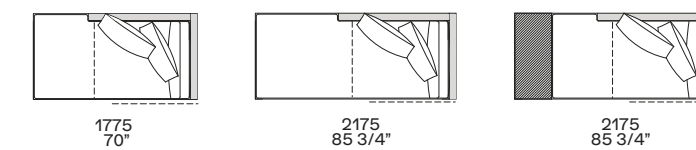

Profondità 1250
Depth 1250 - 49 1/4"

Terminale sx-dx
Lt-rt end unit

bracciolo 200
 arm 200

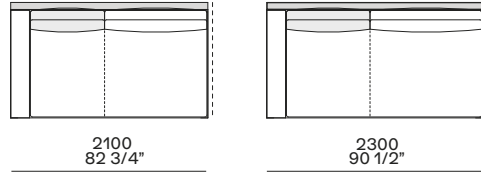

Terminale sx-dx o centrale
Lt-rt end unit or central unit

tavolino 400
 coffee table 400

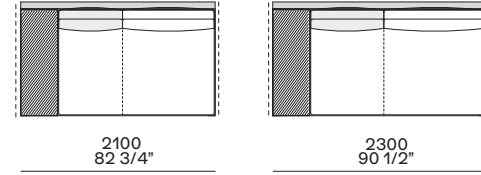

Profondità 1250
Depth 1250 - 49 1/4"

Centrale
Central unit

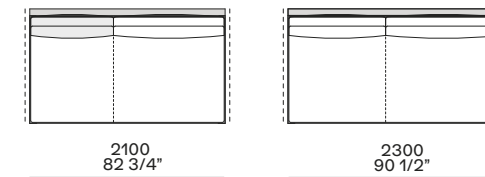

Pouf
Pouf

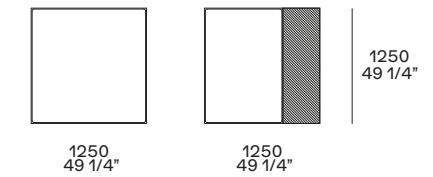

uso centrostanza, terminale o centrale
 freestanding, end unit or central unit

Terminale angolo sx-dx con cuscini schienale
Lt-rt corner end unit with backrest cushions

bracciolo 200
 arm 200

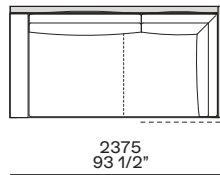

Terminale angolo sx-dx con kit cuscini
Lt-rt corner end unit with kit cushions

bracciolo 200
 arm 200

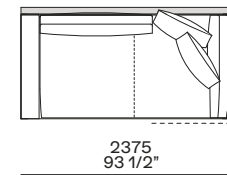

Angolo sx-dx con cuscini schienale
Lt-rt corner unit with backrest cushions

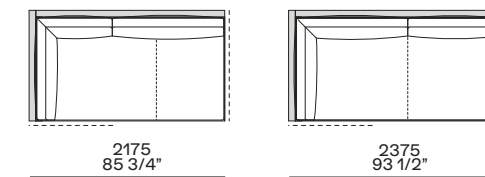

Angolo sx-dx con kit cuscini
Lt-rt corner unit with kit cushions

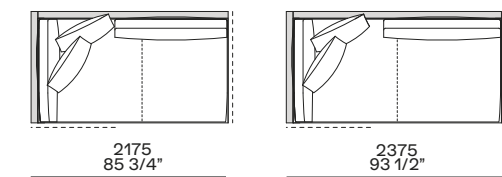

Terminale angolo o angolo sx-dx con cuscini schienale
Lt-rt corner end unit or corner unit with backrest cushions

tavolino 400
 coffee table 400

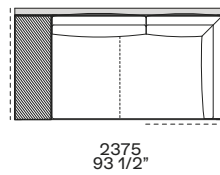

Terminale angolo o angolo sx-dx con kit cuscini
Lt-rt corner end unit or corner unit with kit cushions

tavolino 400
 coffee table 400

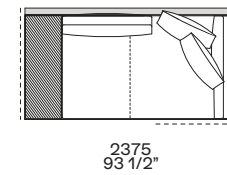

NB
 I cuscini schienale, evidenziati in grigio possono essere sostituiti con un kit cuscini.

The seat cushions indicated in grey can be replaced by a loose cushions kit.

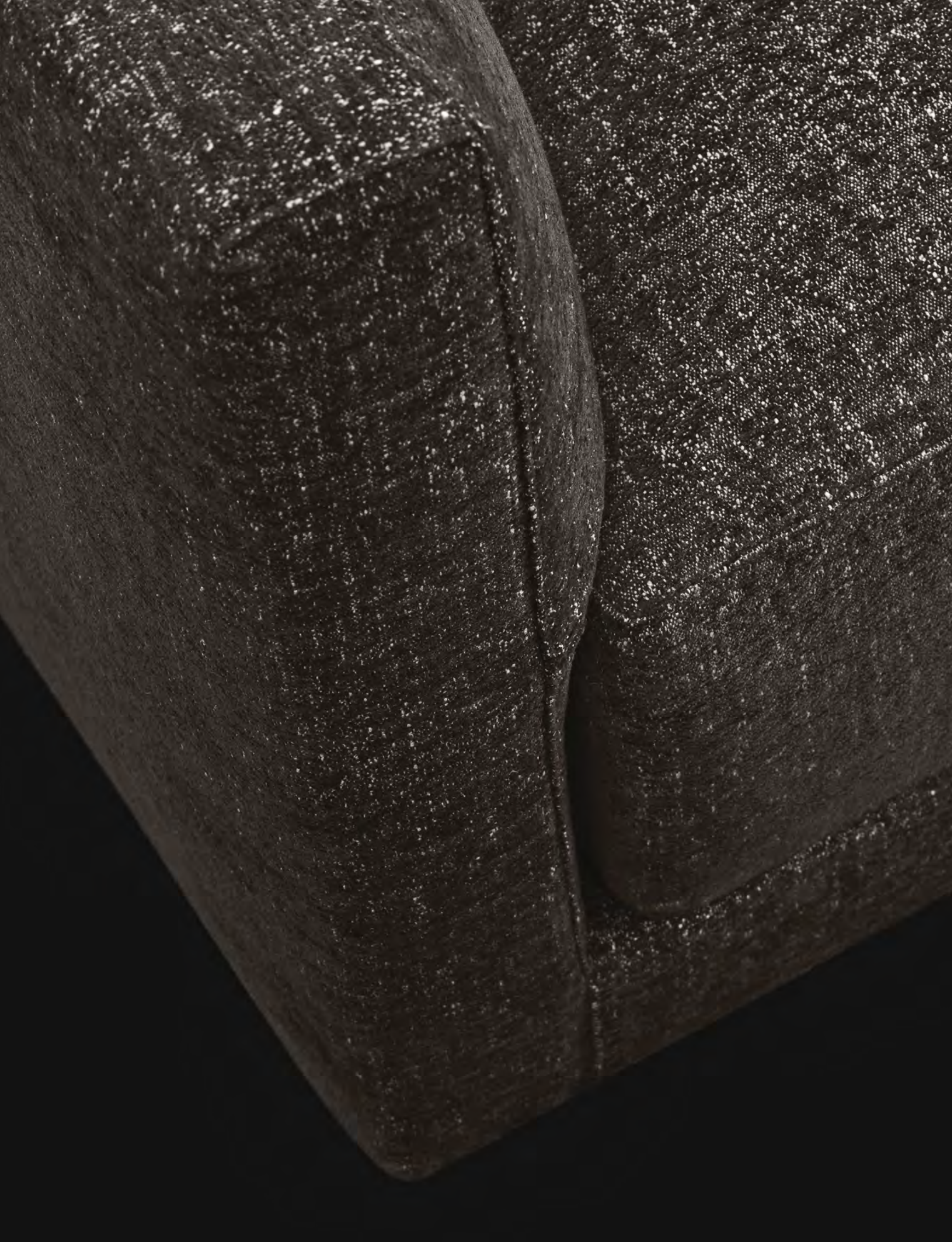

BRISTOL

Il comfort avvolgente della cuscineria e la leggerezza dei braccioli contraddistinguono l'estetica di Bristol, un sistema che offre la massima versatilità compositiva, fra essenzialità del disegno e proporzioni generose. Disponibile con cuscineria semplice, doppia o libera, il divano Bristol si può arricchire con elementi accessori come i tavolini Bristol System, il poggiatesta, il piano scrittoio – per creare zone relax in linea con le proprie esigenze e personalità.

The enveloping comfort of the cushions and the lightness of the armrests distinguish the style of Bristol, a system that offers maximum compositional versatility, between the minimalism of the design and the generous proportions. Available with simple, double, or free cushions, the Bristol sofa can be enriched with accessory elements such as the Bristol System coffee tables, headrest, writing desk – to create relaxation areas in line with your needs and personality.







Qui e nelle pagine precedenti: divano Bristol con cuscinata singola, rivestimento sfoderabile in tessuto Naxos 17 corda con cuscini in tessuto Zante 10 nero. Poltrona Jane in tessuto sfoderabile Persia 54 prussia e basamento in olmo nero. Tavolino Home Hotel in olmo nero. Tavolino Baba in metallo verniciato oro lucido e piano in vetro oro. Pouf Henry in olmo nero e seduta non sfoderabile in velluto Persia 1404 carbone. Tappeto Frame carbone.

This and previous pages: Bristol sofa with single backrest cushion, removable cover in fabric Naxos 17 corda with cushions in fabric Zante 10 nero. Jane armchair in removable fabric Persia 54 prussia and base in black elm. Home Hotel coffee table in black elm. Baba coffee table in glossy gold painted metal and top in gold glass. Henry pouf in black elm with seat in non-removable velvet Persia 1404 carbone. Carpet Frame carbone.







Qui e nella pagina precedente: divano Bristol con cuscinatura singola, rivestimento sfoderabile in pelle Nabuk 08 prussia, cuscini in tessuto Sendai 05 navy e in pelle Nabuk 08 prussia, piedini opzionali in brown nickel lucido. Nella pagina successiva: divano Bristol con cuscinatura doppia e poggiatesta, rivestimento sfoderabile in tessuto Olimpia 111 castagna, cuscini in velluto Persia 1404 carbone, piedini opzionali in brown nickel lucido.

This and previous page: Bristol sofa with single backrest cushion, removable cover in leather Nabuk 08 prussia, cushions in fabric Sendai 05 navy and in leather Nabuk 08 prussia, optional feet in glossy brown nickel. Next page: Bristol sofa with double backrest cushion and headrest, removable cover in fabric Olimpia 111 castagna, cushions in velvet Persia 1404 carbone, optional feet in glossy brown nickel.









Qui e nella pagina precedente: divano Bristol con cuscineria doppia, rivestimento sfoderabile in tessuto Rabat 412 cemento, cuscini in velluto Persia 1404 carbone e 1403 ocra. Pouf Bristol rivestimento sfoderabile in velluto Persia 1404 carbone. Madia e tavolini Bristol in rovere spessart, piedini in brown nickel opaco. Poltrone Mad Chair in velluto sfoderabile Persia 1404 carbone, gambe in rovere spessart. Composizione Wall System laccato lucido moka e rovere cenere, ante scorrevoli Bold in cuoio 02 nero. Sotto: dettaglio del bracciolo fisso opzionale per elementi terminali.

This and previous page: Bristol sofa with double backrest cushion, removable cover in fabric Rabat 412 cemento, cushions in velvet Persia 1404 carbone and 1403 ocra. Bristol pouf with removable cover in velvet Persia 1404 carbone. Sideboard and coffee table Bristol in spessart oak, mat brown nickel feet. Mad Chair armchairs in removable velvet Persia 1404 carbone, legs in spessart oak. Wall Sytem bookcase in moka glossy lacquer and cenere oak, Bold sliding doors in hide 02 nero. Below: close up of the optional fixed armrest for end units.







Qui e nella pagina precedente: divano Bristol con cuscineratura doppia e poggiatesta, rivestimento sfoderabile in tessuto Indra 01 arena, cuscini tessuto Sendai 03 fango e in velluto Persia 1404 carbone, piedini opzionali in brown nickel lucido. Sotto: dettaglio del poggiatesta utilizzabile esclusivamente con cuscineratura doppia.

This and previous page: Bristol sofa with double backrest cushion and headrest, removable cover in fabric Indra 01 arena, cushions in fabric Sendai 03 fango and in velvet Persia 1404 carbone, optional feet in glossy brown nickel. Below: close up of the headrest to be used only with the version with double backrest cushion.





Nella pagina precedente: divano Bristol in tessuto sfoderabile Milos 05 cemento, cuscini velluto Persia 1404 carbone, piedini opzionali in brown nickel opaco e tavolini retrodivano Bristol in olmo nero. Tavolino Bristol piano in marmo calacatta oro levigato e in olmo nero, inserti e piedini in brown nickel opaco. Poltrone Mad Joker rivestimento non sfoderabile, esterno in pelle Nabuk 02 tortora e interno in tessuto Argo 1004 cenere, basamento girevole in brown nickel lucido. Pouf Onda in pelle non sfoderabile Soft 04 cognac. Qui e nella pagina successiva: divano Bristol con cuscineria libera in pelle sfoderabile Nabuk 02 tortora, cuscini in tessuto Lima 63 nero e pelle Nabuk 02 tortora. Tavolini Bristol laterale e centrale in rovere spessart, inserti e piedini in brown nickel opaco. Libreria Wall System in rovere spessart. Madia Pandora laccato lucido visone. Poltrone Ipanema in rovere spessart, cuscino seduta in tessuto sfoderabile Siviglia 04 grafite.

Previous page: Bristol sofa in removable fabric Milos 05 cemento, cushions in velvet Persia 1404 carbone, optional feet in mat brown nickel and Bristol small tables at the back of the sofa in black elm. Bristol coffee table with top in mat marble calacatta oro and in black elm, inlays and feet in mat brown nickel. Mad Joker armchairs with non-removable cover, outer cover in leather Nabuk 02 tortora and inner cover in fabric Argo 1004 cenere, swivel base in glossy brown nickel. Onda pouf in non-removable leather Soft 04 cognac. This and next page: Bristol sofa with loose cushions in removable leather Nabuk 02 tortora, cushions in fabric Lima 63 nero and leather Nabuk 02 tortora. Central and side Bristol coffee tables in spessart oak, inlays and feet in mat brown nickel. Wall System bookcase in spessart oak. Visone glossy lacquered Pandora sideboard. Ipanema armchairs in spessart oak, seat cushion in removable fabric Siviglia 04 grafite.







In questa pagina: divano Bristol con cuscinata doppia e poggiatesta, rivestimento sfoderabile in tessuto Lima 63 nero, cuscini in velluto Persia 1404 carbone e piedini opzionali in brown nickel opaco. Tavolino retro divano e scrittoio Bristol in rovere spessart, inserti e piedini in brown nickel opaco. Pouf Bristol in cuoio 19 caffè. Poltrone Santa Monica rivestimento sfoderabile in pelle Nabuk 04 moka. Tavolino Soori in metallo finitura bronzo anticato.

This page: Bristol sofa with double backrest cushion and headrest, removable cover in fabric Lima 63 nero, cushions in velvet Persia 1404 carbone and optional feet in mat brown nickel. Bristol small table and writing desk in spessart oak, inlays and feet in mat brown nickel. Bristol pouf in hide 19 caffè. Santa Monica armchairs with removable cover in leather Nabuk 04 moka. Soori coffee table in metal with antique bronze finish.



BRISTOL

Design Jean-Marie Massaud, 2014

Struttura in poliuretano flessibile stampato. Cuscino seduta in poliuretano flessibile sagomato, prriverestimento parti in tela cotone e piuma e parti in fibra di poliestere. Cuscino schienale anteriore in Solotex, prriverestimento in tela cotone. Cuscino schienale posteriore in poliuretano flessibile, prriverestimento in fibra di poliestere. Cuscineria libera, cuscini in ovatta di poliestere o piuma, prriverestimento in cotone. Piedini arretrati in materiale plastico (h 45 di serie e h 65 mm) o piedini opzionali in pressofusione d'alluminio verniciato brown nickel opaco e lucido (h 45 mm). Rivestimento sfoderabile in tessuto o pelle.

Structure in flexible moulded polyurethane. Seat cushion in flexible shaped polyurethane, pre-cover with parts in cotton cloth and feather and parts in polyester fibre. Front backrest cushion in Solotex, pre-cover in cotton cloth. Back backrest cushion in flexible polyurethane, pre-cover in polyester fibre. Loose cushions, cushions in polyester padding or feather, pre-cover in cotton cloth. Invisible feet in plastic material (h 45 standard and 65 mm) or optional feet in aluminium die casting painted mat and glossy brown nickel (h 45 mm). Removable cover in fabric or leather.

Tipologie di cuscineria Cushion types



cuscinatura singola
single cushion



cuscinatura doppia
double cushion



cuscinatura libera
loose cushion

Piedini Feet



arretrato, h 45 mm di serie o h 65 mm
recessed, h 45 mm standard or h 65 mm



estetico opzionale h 45
optional h 45 mm

NB

Il divano è disponibile in due altezze:
- h 660 mm, seduta h 360 mm,
piedino arretrato di serie o estetico
opzionale h 45 mm.
- h 680 mm, seduta h 380 mm,
piedino arretrato su richiesta h 65 mm.

È sconsigliato per motivi di allineamento
l'utilizzo degli elementi retro divano
Bristol System con divano h 680 mm.

The sofa is available in two heights:
- h 660 mm - 26", seat h 360 mm - 14 1/4",
standard recessed feet or optional
feet h 45 mm - 1 3/4".
- h 680 mm - 26 3/4", seat h 380 mm - 15",
recessed feet on request h 65 mm - 2 1/2".

For alignment reason it is not recommended
to use Bristol System furniture with sofa
h 680 mm - 26 3/4".

Cuscineria doppia o singola Double or single backrest cushion

Divano Sofa

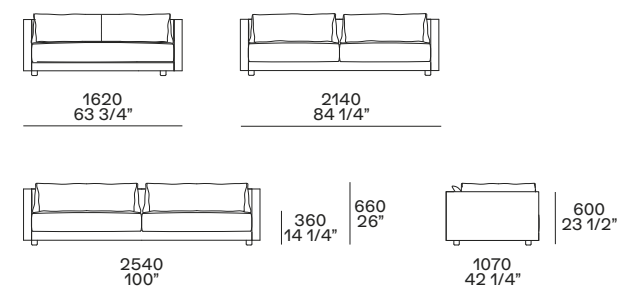

Chaise longue centrostanza Freestanding chaise longue

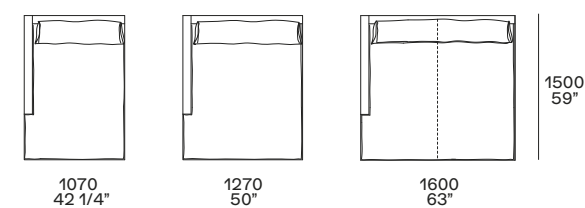

Day Bed centrostanza Freestanding Day Bed

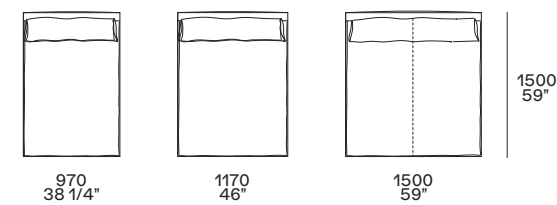

Poggiatesta Headrest

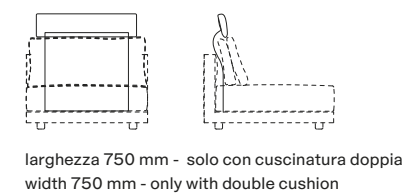

Pouf centrostanza Freestanding pouf

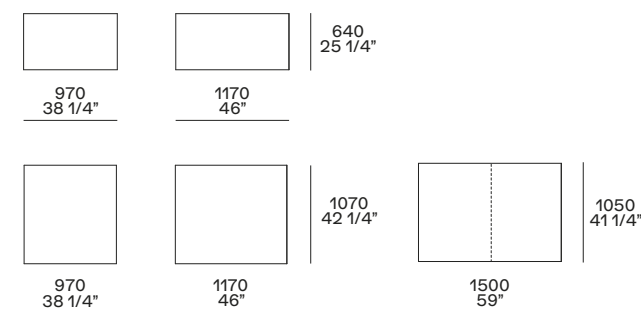

Cuscineria libera Loose cushions

Divano Sofa

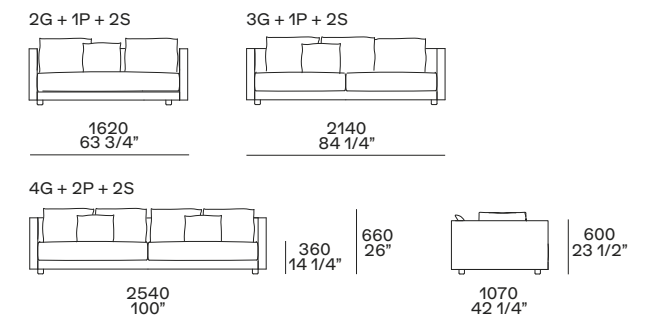

Chaise longue centrostanza Freestanding chaise longue

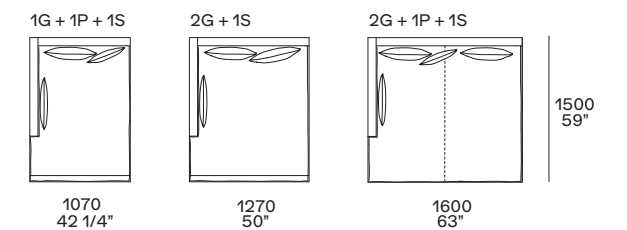

Day Bed centrostanza Freestanding Day Bed

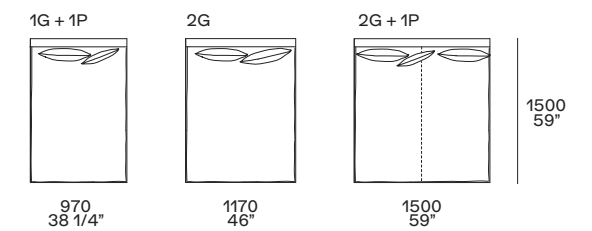

Cuscini Cushions

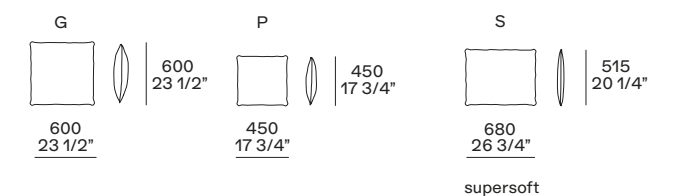

Bracciolo fisso h 482 Fixed arm h 482 - 19"

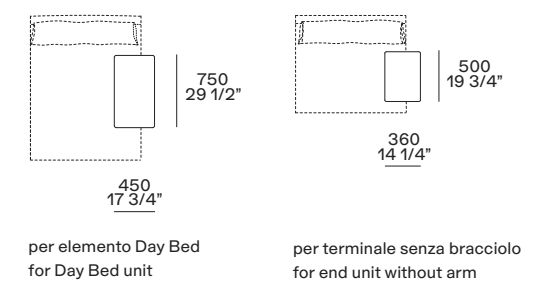

Cuscineria doppia o singola
Double or single backrest cushion

Terminale sx-dx
Lt-rt end unit

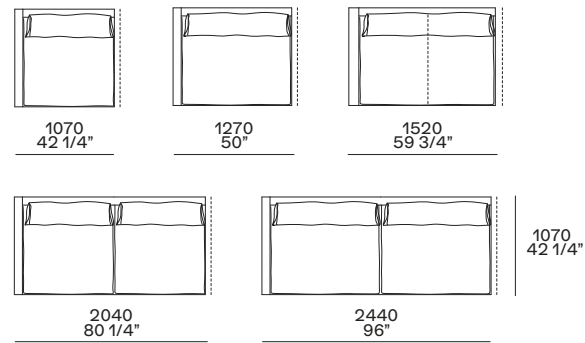

Terminale senza bracciolo sx-dx
Lt-rt end unit whitout arm

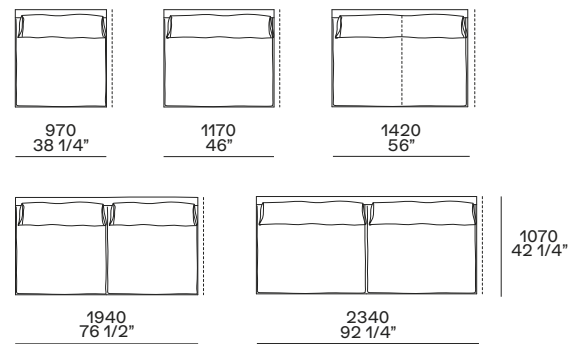

Centrale
Central unit

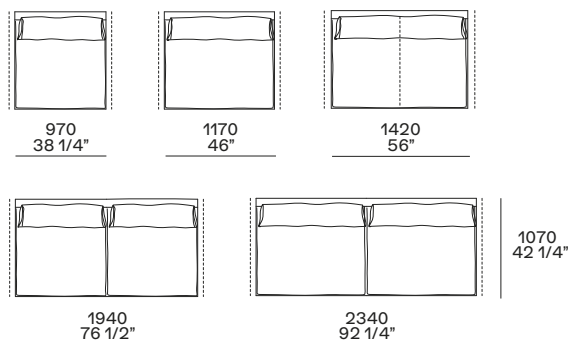

Angolo sx-dx
Lt-rt corner unit

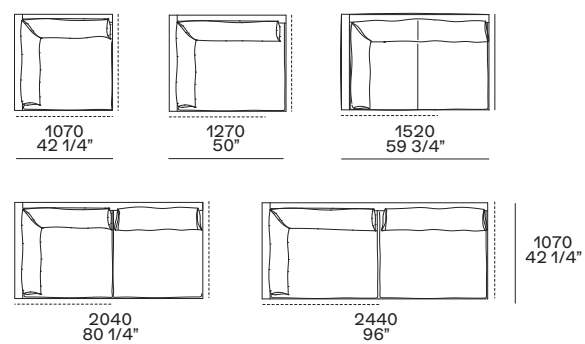

Cuscineria libera
Loose cushions

Terminale sx-dx
Lt-rt end unit

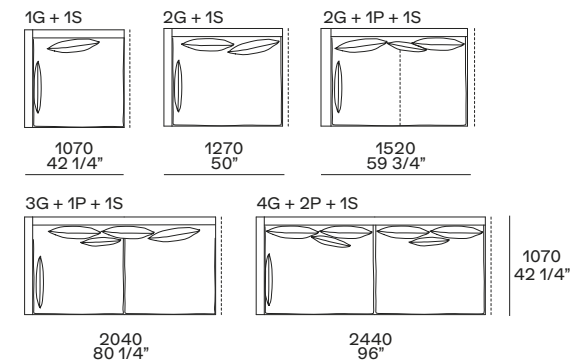

Terminale senza bracciolo sx-dx
Lt-rt end unit whitout arm

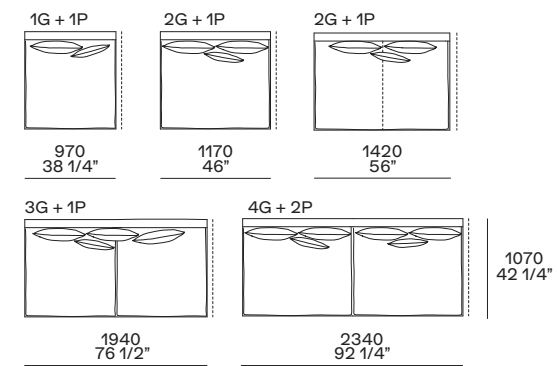

Centrale
Central unit

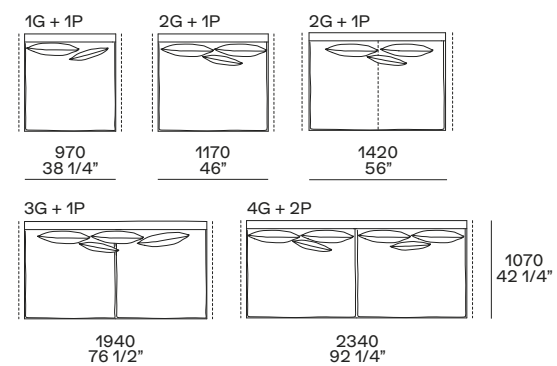

Angolo sx-dx
Lt-rt corner unit

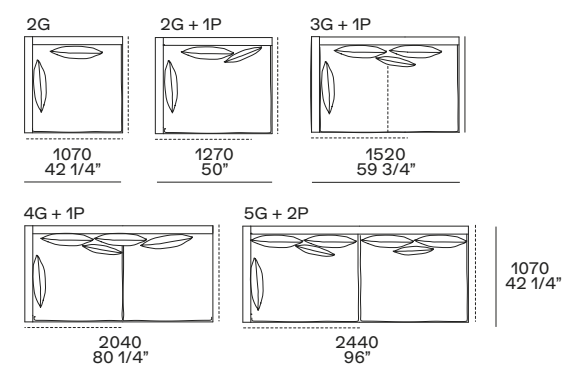

Cuscineria doppia o singola
Double or single backrest cushion

Terminale angolo sx-dx
Lt-rt corner end unit

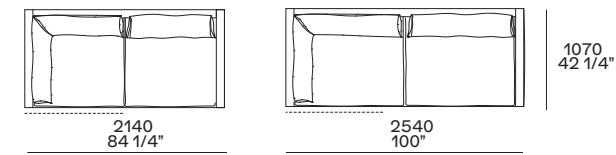

Chaise longue
Chaise longue

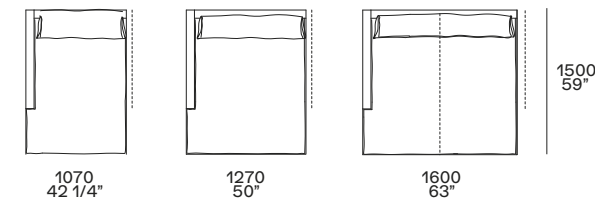

uso centrostanza o terminale
freestanding ro end unit

Chaise longue Day Bed
Day Bed chaise longue

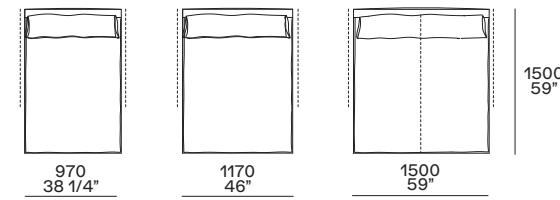

uso centrostanza, terminale o centrale
freestanding, end unit or central unit

Pouf terminale sx-dx
Lt-rt end unit pouf

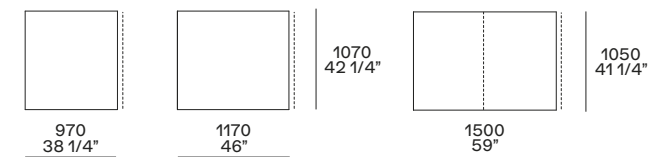

Pouf centrale
Central unit pouf

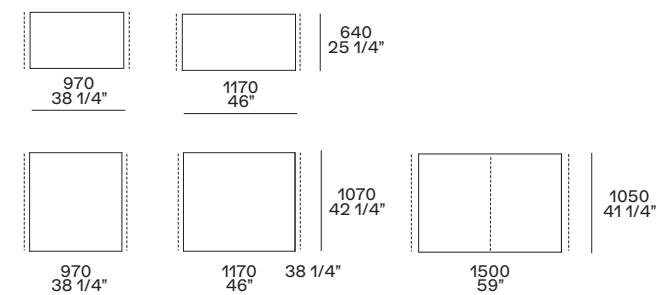

Cuscineria libera
Loose cushions

Terminale angolo sx-dx
Lt-rt corner end unit

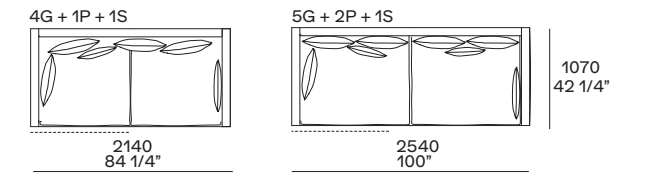

Chaise longue
Chaise longue

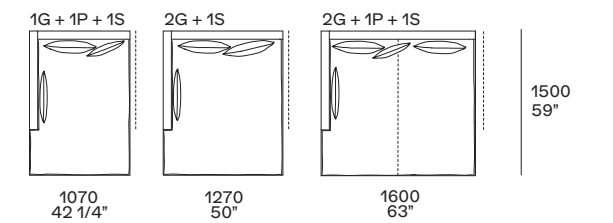

uso centrostanza o terminale
freestanding ro end unit

Chaise longue Day Bed
Day Bed chaise longue

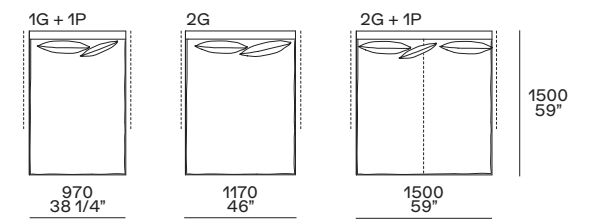

uso centrostanza, terminale o centrale
freestanding, end unit or central unit

Pouf angolo sx-dx
Lt-rt corner pouf

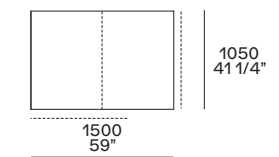

Cuscini
Cushions

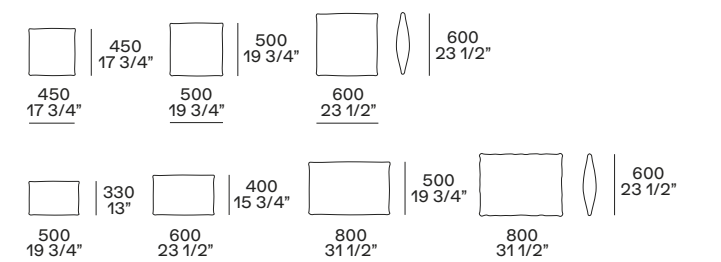

BRISTOL SYSTEM

Design Jean-Marie Massaud, 2014

Serie di tavolini retrodivano o da affiancare lateralmente al divano, attrezzabili con una serie di contenitori; scrittoio con pouf e tavolini centrostanza. Tavolini retrodivano con struttura esterna e interna in laccato opaco colori, laccato lucido colori, rovere spessart o olmo nero. Disponibili anche con struttura esterna in rovere spessart o olmo nero e interno struttura in laccato lucido colori. Inserti e piedini in alluminio verniciato brown nickel opaco o lucido. Contenitori in laccato opaco colori, rovere spessart o olmo nero. Scrittoio in laccato opaco colori, laccato lucido colori, rovere spessart o olmo nero con elemento di sostegno in alluminio verniciato brown nickel opaco o lucido. Pouf in cuoio colori. Tavolini centrostanza con piani in laccato opaco colori, laccato lucido colori, rovere spessart o olmo nero. Piano superiore disponibile anche in marmo bianco carrara, calacatta oro e grigio stardust levigati e lucidi o in noir saint laurent lucido. Inserti e piedini in metallo verniciato brown nickel opaco o lucido.

Series of coffee tables to the back of the sofa or side tables, accessorized with different storage units; writing desk with pouf and small tables for central use. Small tables at the back of the sofa with outer and inner structure available in mat lacquered colours, glossy lacquered colours, spessart oak or black elm. Available also with outer structure in spessart oak or black elm and inner structure in glossy lacquered colours. Inlays and feet in mat or glossy brown nickel painted aluminium. Storage units in mat lacquered colours, spessart oak or black elm. Writing desk available in mat lacquered colours, glossy lacquered colours, spessart oak or black elm with support in mat or glossy brown nickel painted aluminium. Pouf in hide in the available colours. Coffee tables for central use with shelves in mat lacquered colours, glossy lacquered colours, spessart oak or black elm. Top shelf available also in mat and glossy marble bianco carrara, calacatta oro and grigio stardust or in glossy marble noir saint laurent lucido. Inlays and feet in mat or glossy brown nickel painted metal.

Elemento retro divano Element to be placed at the back of the sofa

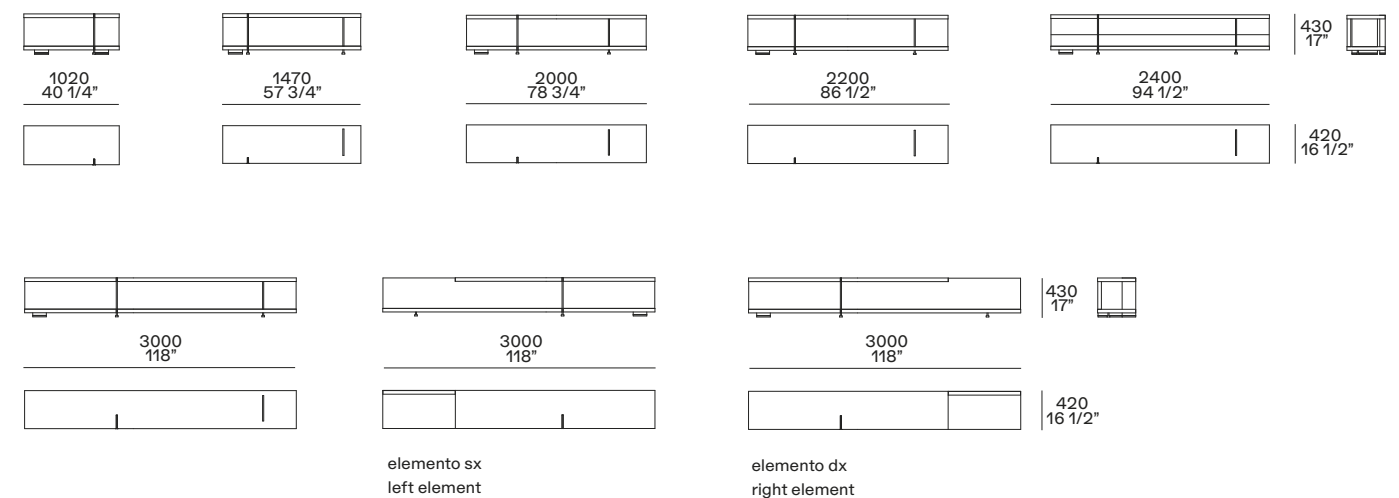

Contenitore anta ribalta o cassetto Storage unit flap door or drawer

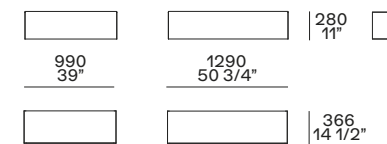

Scrittoio Desk

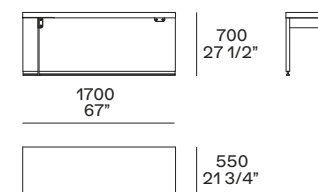

Pouf Pouf

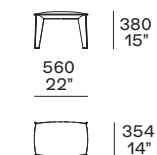

Scrittoio sx- dx da accostare ad un elemento retro divano e ad una madia o disponibile con due sostegni per utilizzo indipendente.

Left- right desk to be used with an element at the back of the sofa or with a sideboard, available also with two metal supports for independent use.

Tavolino centrostanza Freestanding coffee table

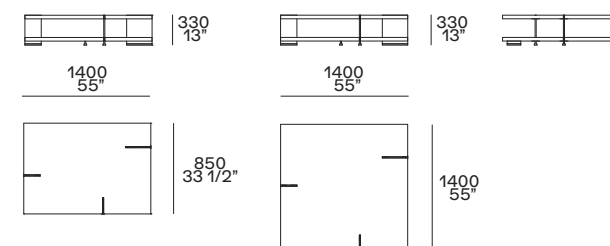

NB

È sconsigliato per motivi di allineamento l'utilizzo degli elementi retro divano Bristol System con divano Bristol h 680 mm.

The use of Bristol System furniture is not recommended with Bristol sofa h 680 mm - 26 3/4".

DUNE

Dune è un sistema di elementi imbottiti dall'aspetto morbido e pieno. Progettato da Carlo Colombo, è molto versatile e permette di creare un numero infinito di composizioni – lineari, ad angolo, con chaise longue. Disponibile in due profondità – large ed extralarge – Dune è la perfetta unione tra semplicità formale e libertà compositiva.

Dune is a system of padded elements with a soft and full look. Designed by Carlo Colombo, it is very versatile and allows you to create an infinite number of compositions – linear, corner, with chaise longue. Available in two depths – large and extra-large – Dune is the perfect union between formal simplicity and compositional freedom.







Qui e nelle pagine precedenti: divano e pouf Dune rivestimento sfoderabile in tessuto Caledonia 05 bianco, cuscini in tessuto Zante 10 nero, velluto Persia 04 carbone e tessuto Caledonia 05 bianco con bordura gros-grain nero. Tavolino Home Hotel in olmo nero. Tavolino Mad Coffee Table in olmo nero con piano in marmo emperador dark levigato. Poltrona Mad Chair rivestimento sfoderabile in tessuto Zante 10 nero, basamento girevole in brown nickel opaco. Madia Giò in olmo nero con piano laccato lucido arena. Tappeto Frame gold.

This and previous pages: sofa and pouf Dune with removable cover in fabric Caledonia 05 bianco, cushions in fabric Zante 10 nero, velvet Persia 04 carbone and fabric Caledonia 05 bianco with border in grosgrain nero. Home Hotel coffee table in black elm. Mad coffee table in black elm with top in mat marble emperador dark. Mad Chair armchair with removable cover in fabric Zante 10 nero, mat brown nickel swivel base. Giò sideboard in black elm with arena glossy lacquered top. Carpet Frame gold.







Nella pagina precedente: divano Dune rivestimento non sfoderabile in pelle Soft 07 roccia, cuscini in tessuto Sendai 02 tortora e pelle Soft 07 roccia con bordura gros-grain nero. Qui e nella pagina successiva: divano Dune rivestimento sfoderabile in tessuto Skyros 02 sabbia, cuscini in tessuto Skyros 02 sabbia e velluto Persia 04 carbone con bordura gros-grain nero.

Previous page: Dune sofa with non-removable cover in leather Soft 03 roccia, cushions in fabric Sendai 02 tortora and leather Soft 03 roccia with border in grosgrain nero. This and next page: Dune sofa with removable cover in fabric Skyros 02 sabbia, cushions in fabric Skyros 02 sabbia and velvet Persia 04 carbone with border in gros-grain nero.





Qui e nella pagina successiva: divano Dune rivestimento sfoderabile in velluto Persia 58 danubio, cuscini in velluto Persia 58 danubio e Persia 1404 carbone con bordura gros-grain sahara. Pouf Dune rivestimento sfoderabile in tessuto Merida 04 lava. Tavolino Soori in metallo finitura bronzo anticato. Tavolino Ipsilon in rovere spessart. Poltrona Santa Monica Lounge rivestimento sfoderabile in tessuto Norway 06 sabbia e cuciture a cordoncino nero.

This and next page: Dune sofa with removable cover in velvet Persia 58 danubio, cushions in velvet Persia 58 danubio and Persia 1404 carbone with grosgrain border sahara. Dune pouf with removable cover in fabric Merida 04 lava. Soori coffee table in metal with antique bronze finish. Ipsilon coffee table in spessart oak. Santa Monica Lounge with removable cover in fabric Norway 06 sabbia and drawstring stitching nero.





DUNE

Design Carlo Colombo, 2008

Struttura in poliuretano flessibile stampato con inserti in poliuretano espanso a quote differenziate. Imbottitura seduta in poliuretano espanso a quote differenziate. Prerivestimento parti in tela cotone con interno in piuma e parti in fibra di poliestere accoppiata. Piedini in materiale plastico. Rivestimento sfoderabile in tessuto e non sfoderabile in pelle. Cuscinatura seduta rivestimento sfoderabile in tessuto o pelle.

Structure in flexible moulded polyurethane with inserts in multi-density polyurethane foam. Seat cushion padding in multi-density polyurethane foam. Pre-cover parts in cotton cloth with feather inside and parts in polyester fibre. Feet in plastic material. Removable cover in fabric and non-removable cover in leather. Seat cushion with removable cover in fabric and leather.

Bracciolo Arm



bracciolo h 550 mm
arm h 550 mm - 21 3/4"



bracciolo h 680 mm
arm h 680 mm - 26 3/4"

Profondità 1020 Depth 1020 - 40 1/4"

Divano Sofa

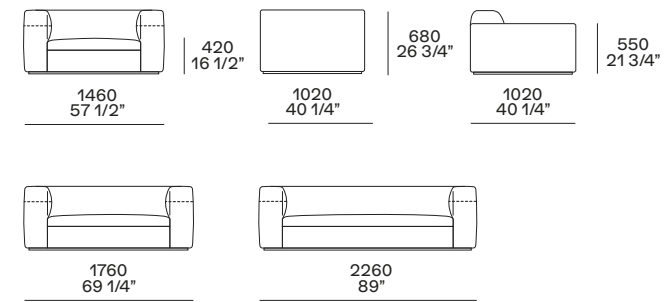

Profondità 1230 Depth 1230 - 48 1/2"

Divano Sofa

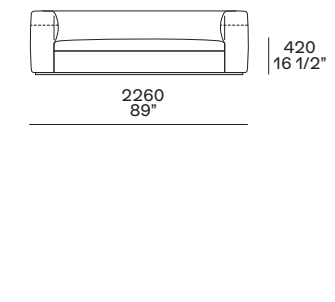

Pouf centrostanza Freestanding pouf

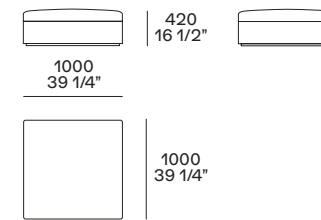

Pouf centrostanza Freestanding pouf

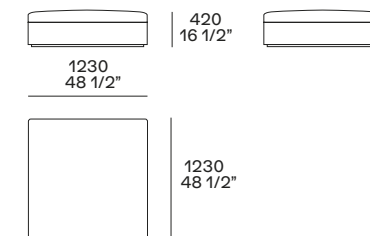

Cuscini Cushions

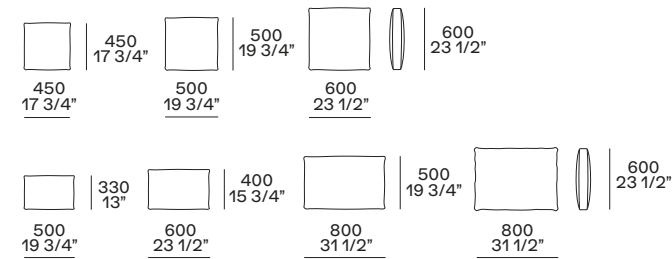

Profondità 1020
Depth 1020 - 40 1/4"

Terminale sx-dx
Lt-rt end unit

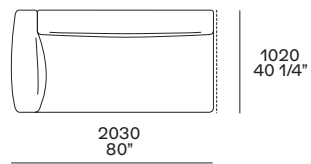
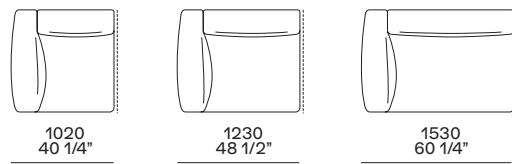

Terminale sx-dx senza bracciolo
Lt-rt end unit whitout arm

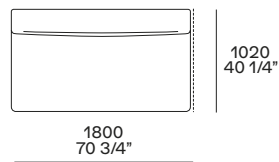
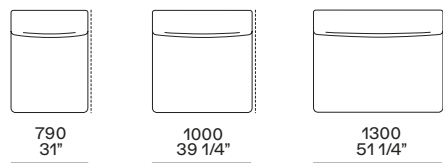

Angolo sx-dx
Lt-rt corner unit

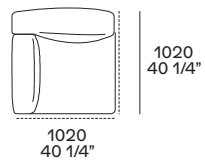

Pouf angolo sx-dx
Lt-rt corner pouf

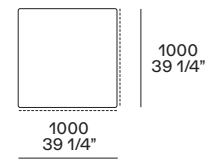

Centrale
Central unit

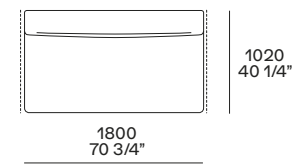
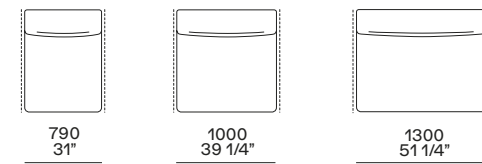

Terminale penisola sx-dx
Lt-rt peninsula end unit

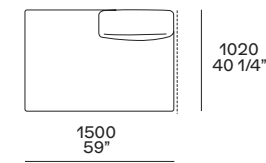

Pouf terminale sx-dx
Lt-rt end unit pouf

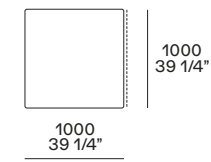

Pouf centrale
Central pouf

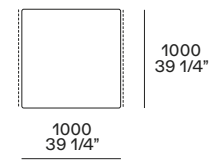

Profondità 1230
Depth 1230 - 48 1/2"

Terminale sx-dx
Lt-rt end unit

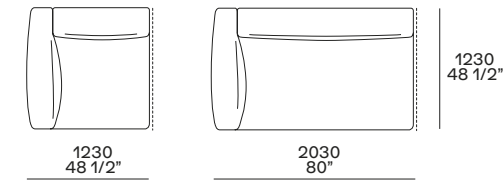

Angolo sx-dx
Lt-rt corner unit

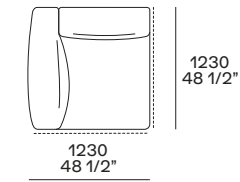

Pouf angolo sx-dx
Lt-rt corner pouf

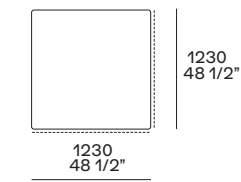

Centrale
Central unit

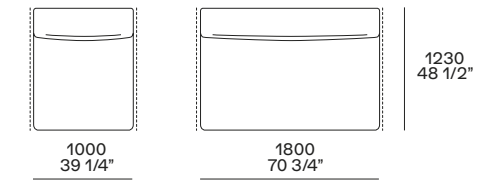

Pouf terminale sx-dx
Lt-rt end unit pouf

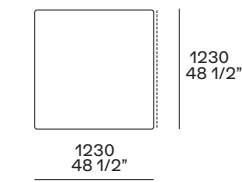

Pouf centrale
Central pouf

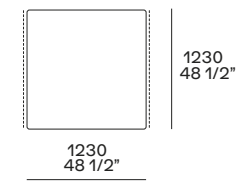

Profondità 1020 e 1230
Depth 1020 - 40 1/4" and 1230 - 48 1/2"

Angolo sx-dx
Lt-rt corner unit

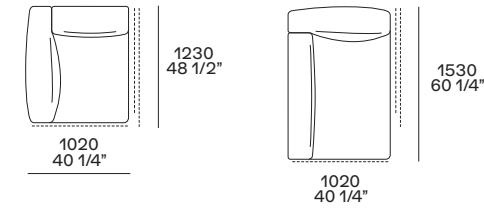

Chaise longue terminale sx-dx
Lt-rt end unit chaise longue

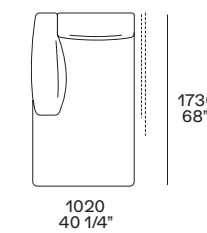
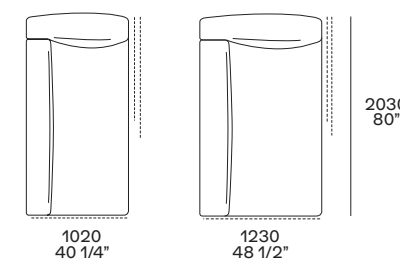
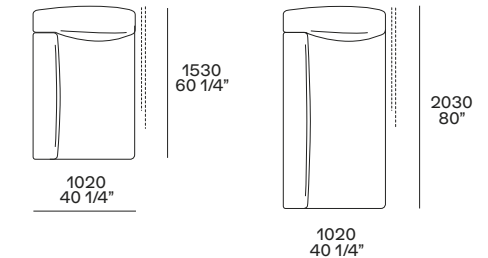

Terminale angolo sx-dx
Lt-rt corner end unit

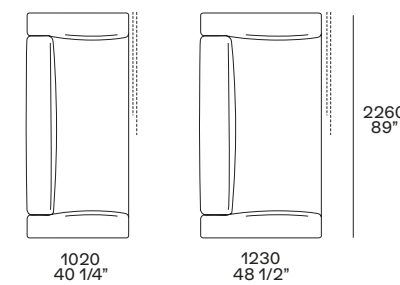

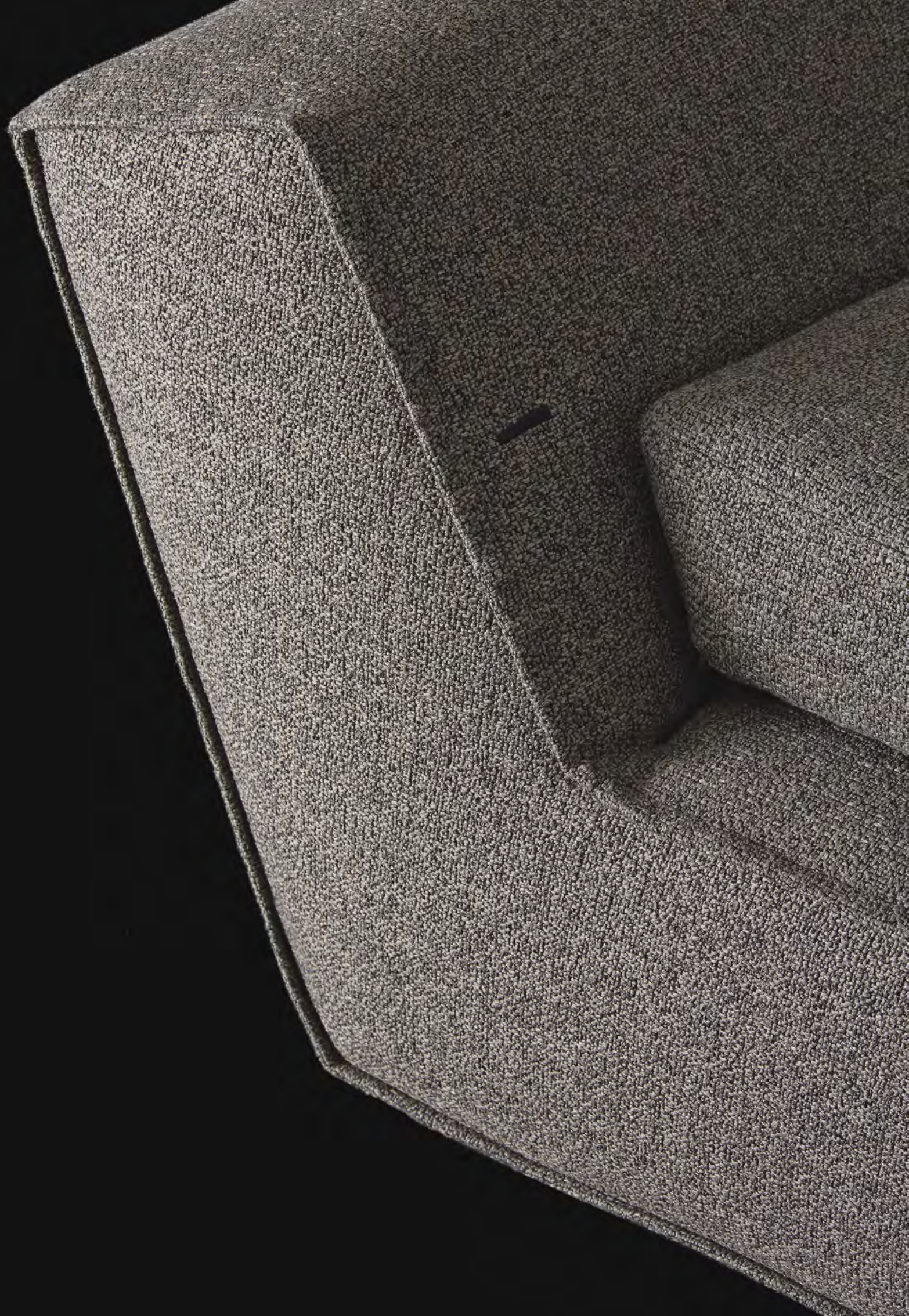

SYDNEY

Una contaminazione di stili, un mix di tendenze, un equilibrio perfetto tra linee oblique e ortogonali, spigoli vivi e arrotondati: con Sydney, Jean-Marie Massaud riesce a trasformare una serie di volumi geometrici in un divano monoscocca morbido e confortevole. Sydney si riconosce per i piedini sottili e per gli elementi a L che costituiscono la seduta, da completare con cuscini liberi di diverse dimensioni e bracciolo opzionale.

A contamination of styles, a mix of trends, a perfect balance between oblique and orthogonal lines, sharp and rounded edges: with Sydney, Jean-Marie Massaud manages to transform a series of geometric volumes into a soft and comfortable monocoque sofa. Sydney distinguishes itself with its thin feet and L-shaped elements that make up the seat, to be completed with free cushions of different sizes and optional armrest.







Qui e nelle pagine precedenti: divano Sydney in tessuto sfoderabile Lima 43 écru con cuciture sahara, cuscini in tessuto Skyros 09 oliva e piedini brown nickel lucido. Tavolini Sydney con struttura e piano in olmo nero e in marmo noir saint laurent lucido. Panca Home Hotel in olmo nero. Sistema giorno Wall System in laccato opaco canapa, schienali in rovere spessart e schienali inclinati in gres porcellanato sahara noir con illuminazione a led integrata. Tappeto Plain natural.

This and previous pages: Sydney sofa in removable fabric Lima 43 écru with stitching sahara, cushions in fabric Skyros 09 oliva and glossy brown nickel feet. Sydney coffee tables with structure and top in black elm and in glossy marble noir saint laurent. Home Hotel bench in black elm. Wall System in mat lacquered canapa, backs in spessart oak and oblique backs in porcelain stoneware sahara noir with integrated led lighting. Carper Plain natural.







Nella pagina precedente: divano Sydney rivestimento sfoderabile in tessuto Naxos 16 sabbia con cuciture burro, cuscini in tessuto Paros 05 bianco e piedini brown nickel lucido. Qui e nella pagina successiva: divano Sydney rivestimento sfoderabile in tessuto Kitami 07 roccia con cuciture navy e piedini brown nickel lucido.

Previous page: Sydney sofa with removable cover in fabric Naxos 16 sabbia with stitching burro, cushions in fabric Paros 05 bianco and glossy brown nickel feet. This and next page: Sydney sofa with removable cover in fabric Kitami 07 roccia with stitching navy and glossy brown nickel feet.





SYDNEY

Design Jean-Marie Massaud, 2016

Struttura in legno e derivati. Imbottitura in poliuretano flessibile a quote differenziate. Prerivestimento in fibra di poliestere. Piedini in metallo verniciato brown nickel lucido. Rivestimento finale sfoderabile in tessuto. Cucitura a cordoncino colori a campionario (escluso velluto).
Cuscini opzionali "sasso" disponibili in tre dimensioni con rivestimento sfoderabile in tessuto o pelle con cucitura a cordoncino colori a campionario (escluso velluto e pelle).

Structure in wood and wood by-products. Padding in multi-density flexible polyurethane. Pre-cover in polyester fibre. Feet in glossy brown nickel painted metal. Final cover in removable fabric. Drawstring stitching in the colours as per sample book (except velvet cover).
Optional "stone" cushions available in three sizes with removable cover in fabric or leather with drawstring stitching in the colours as per sample book (except velvet and leather cover).

Terminale sx-dx Lt-rt end unit

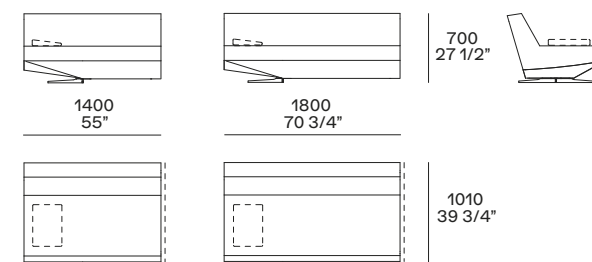

Terminale penisola sx-dx Lt-rt peninsula end unit

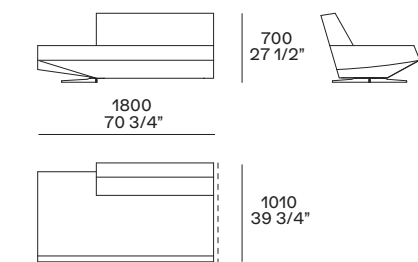

Centrale Central unit

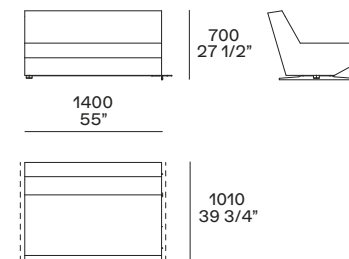

Angolo Corner unit

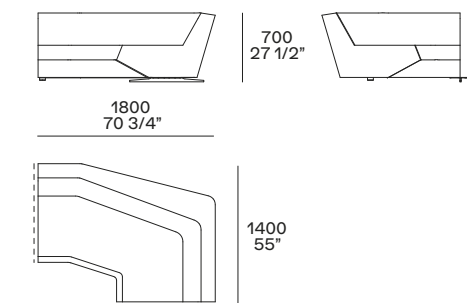

Terminale chaise longue sx-dx Lt-rt end unit chaise longue

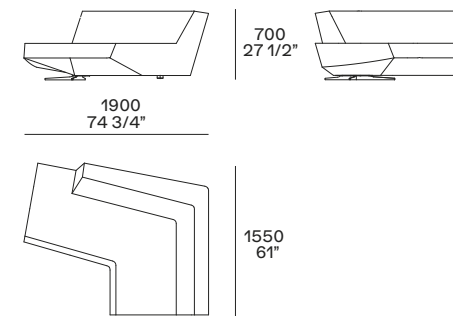

Cuscini Cushions

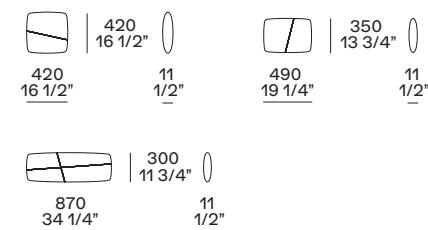

Bracciolo opzionale Optional armrest

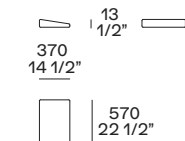

per terminale sx-dx
for lt-rt end unit



TRIBECA

Uno stile contemporaneo e internazionale caratterizza il divano Tribeca di Jean-Marie Massaud, in cui la morbidezza delle forme, sostenute da una sottile struttura in metallo, è impreziosita dal particolare bracciolo. Un insieme armonico che trasforma il divano Tribeca, fisso o componibile, nel protagonista della zona giorno.

A contemporary and international style characterizes the Tribeca sofa by Jean-Marie Massaud, in which the softness of the shapes, supported by a thin metal structure, is embellished by the particular armrest. A harmonious whole that transforms the Tribeca sofa, fixed or modular, into the protagonist of the day area.







Qui e nelle pagine precedenti: divano e pouf Tribeca rivestimento sfoderabile in tessuto Oxford 11 sabbia, cuscini in velluto Persia 1404 carbone e piedini in brown nickel opaco. Tavolino Tribeca con struttura in brown nickel opaco e piano in marmo calacatta oro lucido. Tavolino Baba in brown nickel opaco e piano in marmo emperador dark lucido. Poltrone Santa Monica Home rivestimento sfoderabile in tessuto Norway 19 prussia. Sistema a giorno Wall System in rovere cenere, griglie interne laccato opaco piombo, ribalta sporgente Jet in rovere cenere, vetrine sporgenti Ghost in vetro trasparente riflettente con telaio verniciato ardesia e schienali laccato opaco caramello.

This and previous pages: Tribeca sofa and pouf with removable cover in fabric Oxford 11 sabbia, cushions in velvet Persia 1404 carbone and feet in mat brown nickel. Tribeca coffee table with mat brown nickel structure and top in glossy marble calacatta oro. Baba coffee table in mat brown nickel and top in glossy marble emperador dark. Santa Monica Home armchairs with removable cover in fabric Norway 19 prussia. Wall System in cenere oak, piombo mat lacquered inner grids, Jet jutting flap door in cenere oak, Ghost jutting showcases in transparent reflecting glass with ardesia painted frame and caramello mat lacquered backs.







Qui e nella pagina precedente: divano e pouf Tribeca rivestimento sfo-
derabile in pelle Soft 13 carbone, cuscini in tessuto Zante 10 nero e
pelle Soft 13 carbone, piedini in brown nickel opaco.

This and previous page: Tribeca sofa and pouf with removable cover in
leather Soft 13 carbone, cushions in fabric Zante 10 nero and leather
Soft 13 carbone, mat brown nickel feet.



In questa pagina: divano Tribeca rivestimento sfoderabile in tessuto Nayoro 03 tortora, cuscini in velluto Persia 1404 carbone e piedini in brown nickel opaco. Tavolino Tribeca con struttura in brown nickel opaco e piani in marmo emperador dark lucido e in rovere spessart. Poltrona Santa Monica rivestimento sfoderabile in pelle Soft 13 carbone. Pouf Elise rivestimento non sfoderabile in pelle Nabuk 04 moka. Libreria pensile Slego in rovere spessart.

This page: Tribeca sofa with removable cover in fabric Nayoro 03 tortora, cushions in velvet Persia 1404 carbone and mat brown nickel feet. Tribeca coffee table with mat brown nickel structure and top in glossy marble emperador dark and in spessart oak. Santa Monica armchair with removable cover in leather Soft 13 carbone. Elise pouf with non-removable cover in leather Nabuk 04 moka. Slego hanging bookcase in spessart oak.



TRIBECA

Design Jean-Marie Massaud, 2012

Struttura basamento in legno e derivati. Schienale e braccioli in poliuretano flessibile stampato in doppia densità. Cuscino seduta in poliuretano flessibile a quote differenziate. Prerivestimento in fibra di poliestere, tela cotone con interno in piuma. Piedini in metallo verniciato brown nickel opaco o lucido. Rivestimento sfoderabile in tessuto o pelle.

Base structure in wood and wood by-products. Backrest and armrests in flexible moulded polyurethane with double density. Seat cushion in flexible multi-density polyurethane. Pre-cover in polyester fibre, cotton cloth with feather inside. Feet in mat or glossy brown nickel painted metal. Removable cover in fabric or leather.

Divano Sofa

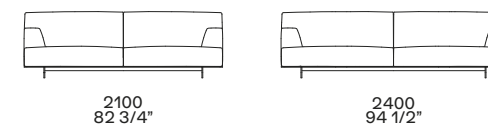

Terminale sx-dx Lt-rt end unit

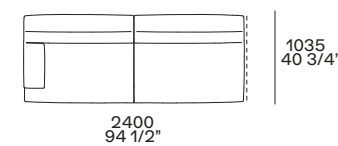
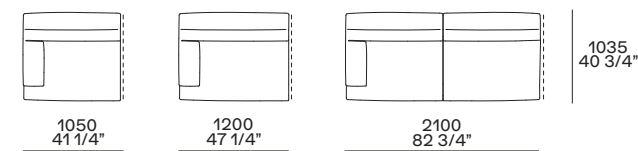

Terminale penisola sx-dx Lt-rt peninsula end unit

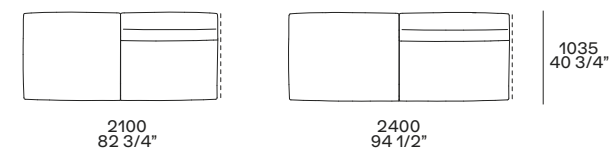

Terminale angolo penisola sx-dx Lt-rt corner end unit peninsula



Chaise longue terminale sx-dx Lt-rt end unit chaise longue

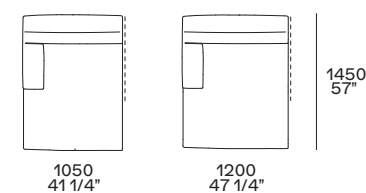

Panca Bench

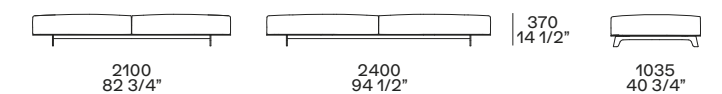

Pouf centrostanza Freestanding pouf

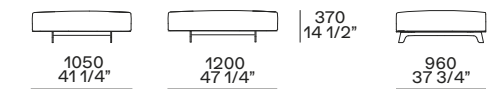

Angolo sx-dx Lt-rt corner unit

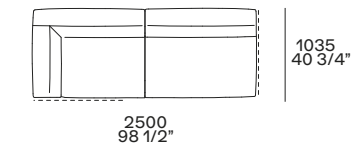
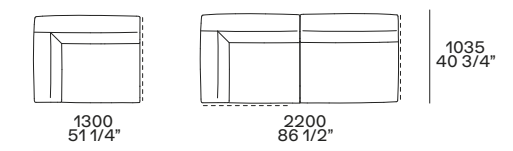

Terminale angolo sx-dx Lt-rt corner end unit

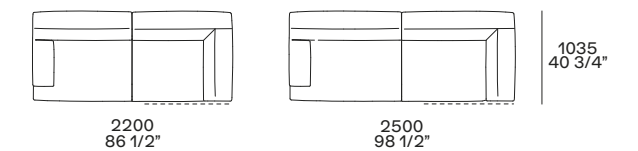

Centrale Central unit

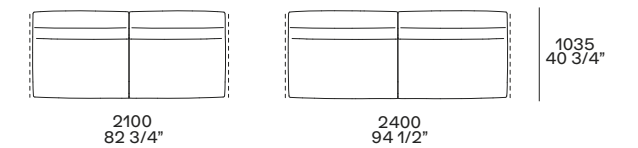

Cuscini Cushions

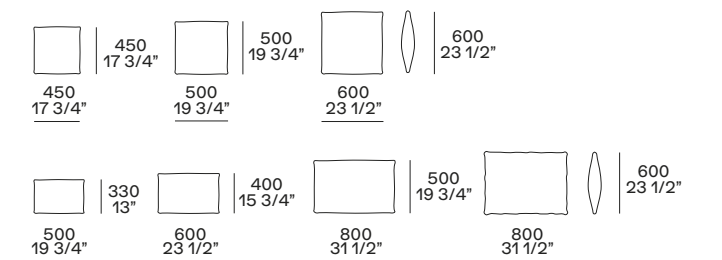



SHANGAI

Shangai di Carlo Colombo è un sistema di divani dalle forme rigorose, declinato in due versioni di imbottitura – la prima più classica e la seconda, in piuma, più morbida e informale. Il basamento in alluminio, che sembra una linea sottile, è un dettaglio di carattere dal tocco contemporaneo.

Shangai by Carlo Colombo is a system of sofas with rigorous shapes, available in two versions of padding – the first more classic and the second, in feather, softer and more informal. The aluminium base, which looks like a thin line, is a detail with a contemporary touch.





Qui e nelle pagine precedenti: divano e pouf Shangai, versione in piuma, rivestimento sfoderabile in tessuto Hannover 14 grafite, cuscini in tessuto Norway 06 sabbia, zoccolino estetico in alluminio brill. Tavolino Bigger con struttura in rovere spessart e piano in laccato lucido granata. Tavolino Flute in laccato lucido granata. Poltrona Ipanema in rovere spessart e seduta con rivestimento non sfoderabile in pelle Nabuk 01 latte. Pouf Elise con rivestimento sfoderabile in tessuto Rabat 412 cemento e cucitura a cordoncino nero.

This and previous pages: Shangai sofa and pouf, feather version, removable cover in fabric Hannover 14 grafite, cushions in fabric Norway 06 sabbia, decoration plinth in aluminium brill. Bigger coffee table with spessart oak structure and granata glossy lacquered top. Granata glossy lacquered Flute coffee table. Ipanema armchair in spessart oak and seat with non-removable cover in leather Nabuk 01 latte. Elise pouf with removable cover in fabric Rabat 412 cemento and drawstring stitching nero.







Qui e nella pagina precedente: divano Shangai, versione in fibra, rivestimento sfoderabile in tessuto Skyros 04 visone, cuscini in velluto Persia 1404 carbone e tessuto Skyros 04 visone, zoccolino estetico in brown nickel opaco.

This and previous page: Shangai sofa, fibre version, removable cover in fabric Skyros 04 visone, cushions in velvet Persia 1404 carbone and fabric Skyros 04 visone, decoration plinth in mat brown nickel.



SHANGAI

Design Carlo Colombo, 2006

Struttura in legno e derivati. Imbottitura struttura, seduta e schienale in poliuretano a quote differenziate. Prerivestimento versione in piuma e parti in fibra di poliestere accoppiata. Prerivestimento versione fibra in fibra di poliestere accoppiata. Piedini in materiale plastico e zoccolino estetico in alluminio brill o in alluminio verniciato brown nickel opaco e lucido. Rivestimento sfoderabile in tessuto e non sfoderabile in pelle.

Structure in wood and wood by-products. Padding of structure, seat cushion and backrest is multi-density polyurethane. Pre-cover for the feather version, parts in cotton cloth with feather inside and parts in polyester fibre. Pre-cover for the fibre version in polyester fibre. Feet in plastic material and decoration plinth in aluminium brill or in aluminium painted mat and glossy brown nickel. Removable cover in fabric and non-removable in leather.

Divano Sofa

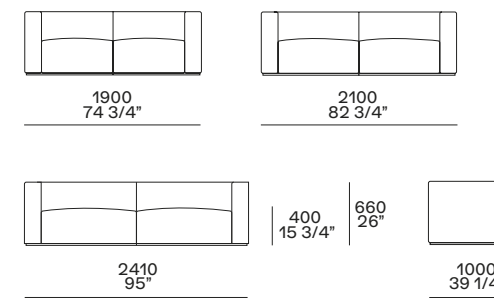

Pouf centrostanza Freestanding pouf

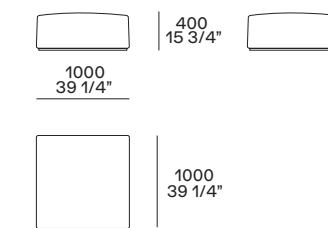

Terminale sx-dx Lt-rt end unit

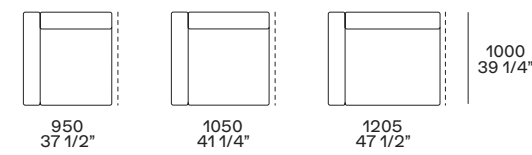

Centrale o terminale senza bracciolo sx-dx Central unit or lt-rt end unit without arm

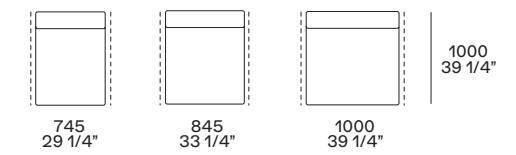

Angolo sx-dx Lt-rt corner unit

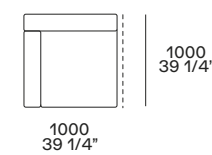

Pouf angolo sx-dx Lt-rt corner pouf

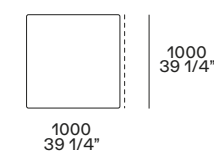

Pouf terminale sx-dx Lt-rt end unit pouf

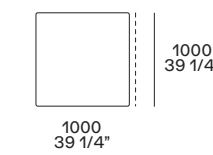

Pouf centrale Central unit pouf

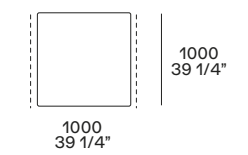

Chaise longue terminale sx-dx Lt-rt end unit chaise longue

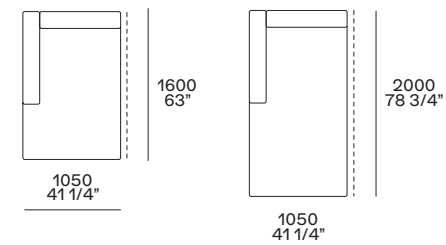

Cuscini Cushions

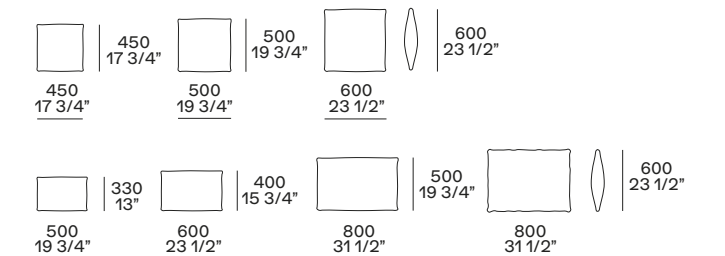



PARIS SEOUL

Proporzioni generose per Paris Seoul, la collezione di divani disegnata da Jean-Marie Massaud. Un'estetica ultrabold per un archetipo dell'imbottito, che riconduce ogni elemento alla sua forma primaria. Una proposta elegante e completa per le atmosfere più classiche del living, capace di realizzare un comfort evoluto, grazie al meccanismo che permette di regolare a piacere la profondità della seduta.

Generous proportions for Paris Seoul, the sofa collection designed by Jean-Marie Massaud. An ultra-bold aesthetic for an archetype of upholstery, bringing each element back to its primary shape. An elegant and complete offer for the most classic atmosphere of the living area, able to create an evolved comfort, thanks to the mechanism that allows you to adjust the depth of the seat as desired.







Qui e nelle pagine precedenti: divano e pouf Paris Seoul rivestimento sfoderabile in tessuto Merida 99 écreu, cuscini in velluto Persia 2006 prugna. Tavolino Paris Seoul in cuoio 02 nero e interno struttura in brown nickel opaco. Tavolini Tribeca con struttura in brown nickel opaco e piani in marmo emperador dark lucido. Poltrona Soori Highline rivestimento non sfoderabile in velluto Persia 2006 prugna e bordure gros-grain nero, struttura in rovere spessart. Composizione Wall System con struttura, schienali e inserti attrezzati in rovere spessart, ante Slim a ribalta laccato opaco visone.

This and previous pages: sofa and pouf Paris Seoul covered in removable fabric Merida 99 écreu, cushions in velvet Persia 2006 prugna. Paris Seoul coffee table in hide 02 nero and inner structure in mat brown nickel. Tribeca coffee tables with mat brown nickel structure and top in glossy marble emperador dark. Soori Highline armchair with non-removable cover in velvet Persia 2006 prugna and border in grosgrain nero, structure in spessart oak. Wall System bookcase with structure, backs and accessorized inserts in spessart oak, visone mat lacquered Slim flap doors.







Qui e nella pagina precedente: divano e pouf Paris Seoul rivestimento sfoderabile in tessuto Paros 12 cemento, cuscini in tessuto Norway 03 nero e Paros 12 cemento. Il divano Paris Seoul è caratterizzato da un meccanismo che permette di variare la profondità della seduta in due diverse posizioni. A sinistra: dettaglio delle due diverse posizioni della seduta.

This and previous page: sofa and pouf Paris Seoul with removable cover in fabric Paros 12 cemento, cushions in fabric Norway 03 nero and Paros 12 cemento. Paris Seoul sofa is distinguished by a mechanism, which allows changing the seat depth in two positions. Left: close up of the two different seat positions.



PARIS SEOUL

Design Jean-Marie Massaud, 2012

Struttura e basamento in legno e derivati. Imbottitura schienale e braccioli in poliuretano flessibile stampato in doppia densità. Imbottitura cuscino seduta in poliuretano flessibile a quote differenziate e molle. Seduta con meccanismo per regolazione in profondità in due posizioni fisse. Prerivestimento in fibra di poliestere, tela cotone e piuma. Piedini in materiale plastico. Rivestimento sfoderabile in tessuto o pelle.

Structure and base in wood and wood by-products. Padding of backrest cushion and armrests in flexible moulded polyurethane with double density. Padding of seat cushion in multi-density flexible polyurethane and springs. Seat with mechanism to adjust the depth in two fixed positions. Pre-cover in polyester fibre, cotton cloth and feather. Feet in plastic material. Removable cover in fabric or leather.

Regolazione seduta Seat adjustment



posizione 1
position 1



posizione 2
position 2

Terminale sx-dx Lt-rt end unit

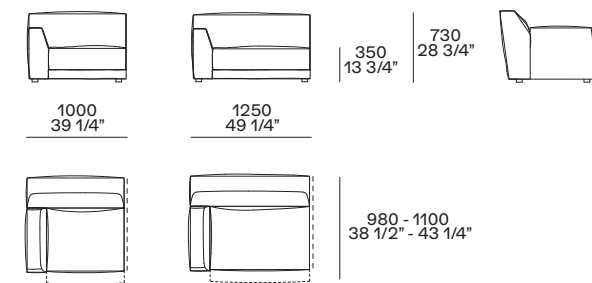

Pouf centrostanza Freestanding pouf

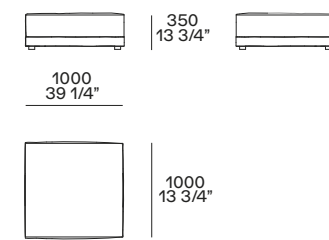

Centrale Central unit

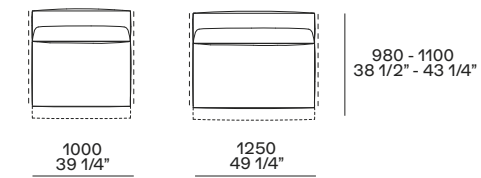

Angolo sx-dx Lt-rt corner unit

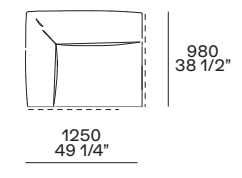

Pouf terminale sx-dx Lt-rt end unit pouf

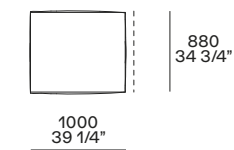

Chaise longue terminale sx-dx Lt-rt end unit chaise longue

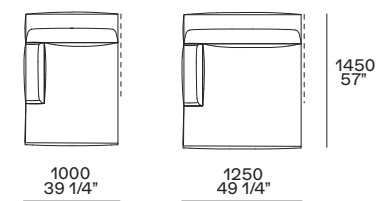

Cuscini Cushions

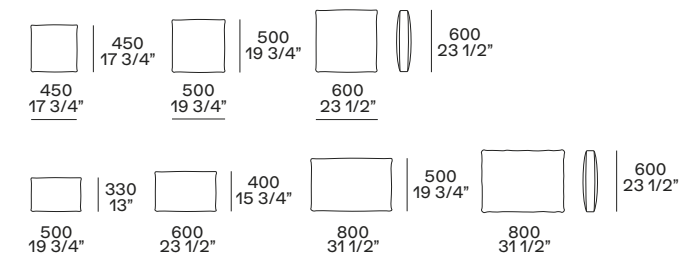

AIRPORT



Volumi extralarge, linee morbide, stile informale: Airport è un'isola di comfort che promette momenti di relax da vivere in libertà. Disegnato da Paola Navone, il divano Airport è straordinariamente morbido e ha uno stile ancora più rilassato nella versione non tesata.

Extra-large volumes, soft lines, informal style: Airport is an island of comfort that promises moments of relaxation to experience in freedom. Designed by Paola Navone, the Airport sofa is extraordinarily soft and has an even more relaxed style in the non-stretched version.







Nelle pagine precedenti: divano Airport rivestimento non sfoderabile in tessuto Siviglia 01 bianco con doppia cucitura overlock, cuscini in tessuto Sendai 01 cenere e Siviglia 48 bosco e 04 grafite. Tavolino Flute in laccato lucido pioggia. Libreria Wall System in laccato opaco bianco. Qui e nella pagina successiva: divano Airport con cuscini schienale, rivestimento tesato non sfoderabile in pelle Nabuk 10 oliva, cuscini in pelle Nabuk 10 oliva e velluto Persia 1404 carbone.

Previous pages: Airport sofa with removable slipcover in fabric Siviglia 01 bianco with double overlock stitching, cushions in fabric Sendai 01 cenere and Siviglia 48 bosco and 04 grafite. Pioggia glossy lacquered Flute coffee table. Bianco mat lacquered Wall System bookcase. This and next page: Airport sofa with backrest cushions, non-removable stretched cover in leather Nabuk 10 oliva, cushions in leather Nabuk 10 oliva and velvet Persia 1404 carbone.



AIRPORT

Design Paola Navone, 2006

Struttura legno e derivati. Imbottitura struttura e seduta in poliuretano a quote differenziate e molle. Imbottitura schienale in poliuretano a quote differenziate. Prerivestimento in fibra di poliestere accoppiata. Piedini in materiale plastico. Rivestimento versione tesato non sfoderabile in pelle. Rivestimento versione non tesato sfoderabile in tessuto con cucitura doppia overlock.

Structure in wood and wood by-products. Padding of structure and seat cushion in multi-density polyurethane and springs. Backrest padding in multi-density polyurethane. Pre-cover in polyester fibre. Feet in plastic material. Cover of the stretched version non-removable in leather. Slipcover version removable in fabric with double overlock stitching.

Divano Sofa

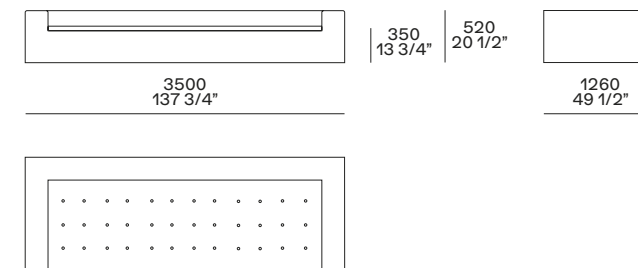
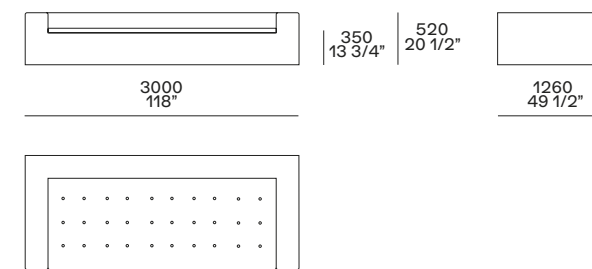
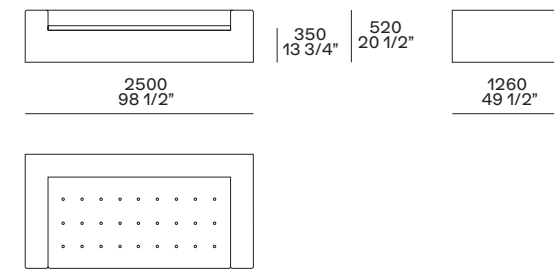

Divano con cuscini schienale Sofa with backrest cushions

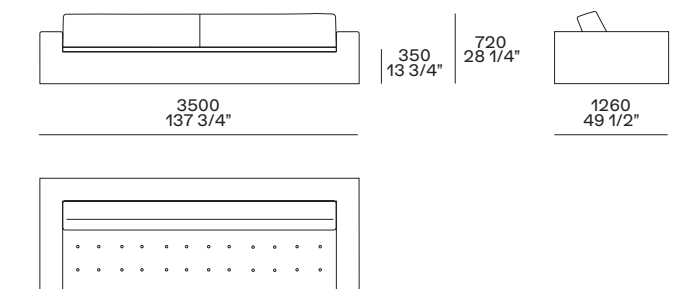
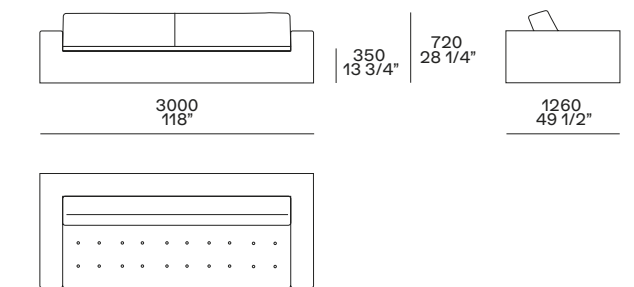
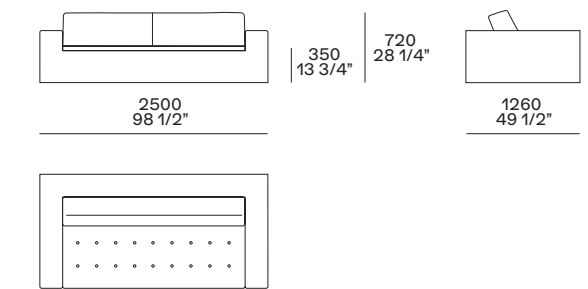

Cuscini Cushions

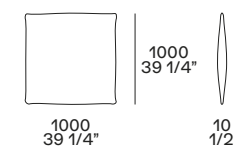
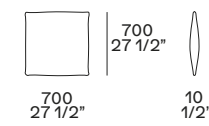

ARMCHAIRS

Uno spazio personale in cui abbandonarsi al relax: la poltrona secondo Poliform. Pensata per la zona giorno ma ideale in tutti gli ambienti della casa votati al comfort, è la perfetta unione tra volumi pieni e imbottiture morbide che invitano alla seduta. Tessuti e pelli aggiungono piacevoli sensazioni tattili. I designer sono Jean-Marie Massaud, Marcel Wanders, Emmanuel Gallina, Vincent Van Duysen, Soo Chan, Paola Navone, Blumer e Borghi.

A personal space to indulge in relaxation: the armchair according to Poliform. Designed for the day area but ideal in all the environments of the house devoted to comfort, it is the perfect combination of full volumes and soft padding that invite you to the seat. Fabrics and leathers add pleasant tactile sensations. The designers are Jean-Marie Massaud, Marcel Wanders, Emmanuel Gallina, Vincent Van Duysen, Soo Chan, Paola Navone, Blumer and Borghi.

ARMCHAIRS

JANE	219
JANE LARGE	232
JANE LOUNGE	240
MAD CHAIR	249
MAD JOKER	266
MAD QUEEN	274
MAD CHAISE LONGUE	282
MAD KING	286
STANFORD	295
STANFORD LOUNGE	306
SANTA MONICA	315
SANTA MONICA LOUNGE	324
SANTA MONICA HOME	332
BELLPORT	341
MARLON	351
IPANEMA	363
VENTURA LOUNGE	375
CAMILLA	387
SOORI HIGHLINE	397
GASTON	407
BB	417
WALLACE	427
BIG BUG	435



JANE COLLECTION

La collezione Jane è ispirata all'idea di ambienti eleganti nei quali ritagliare spazi dedicati a comfort e intimità. L'omonima poltrona dalle dimensioni contenute, morbida e compatta, esprime uno stile contemporaneo e senza tempo. Le stesse armoniose proporzioni si ritrovano nei volumi più generosi del divanetto, di Jane Large e di Jane Lounge, e nelle declinazioni del pouf e della panca imbottita.

The Jane collection is inspired by the idea of elegant environments where you can create spaces dedicated to comfort and intimacy. The homonymous armchair of small dimensions, soft and compact, expresses a contemporary and timeless style. The same harmonious proportions can be found in the most generous volumes of the love seat, of Jane Large, and of Jane Lounge, and in the variations of the pouf and the upholstered bench.





Nella pagina precedente: poltrona Jane rivestimento sfoderabile in velluto Persia 54 prussia e basamento in olmo nero. Tappeto Frame carbone. In questa pagina: divani Jane rivestimento sfoderabile in tessuto Orleans 12 carbone e basamento in olmo nero. Poltrone Jane rivestimento non sfoderabile in pelle Soft 10 prugna e basamento in olmo nero. Tavolino Henry in olmo nero con piano in vetro lucido bordeaux. Tavolino Soori in metallo con finitura bronzo anticato. Tappeto Frame perla. Sullo sfondo: Quid bacheche a giorno in olmo nero e ripiani in laccato opaco moka. Tavolino Dama laccato lucido canapa.

Previous page: Jane armchair with removable cover in velvet Persia 54 prussia and base in black elm. Carpet Frame carbone. This page: Jane sofas with removable cover in fabric Orleans 12 carbone and base in black elm. Jane armchairs with non-removable cover in leather Soft 10 prugna and base in black elm. Henry coffee table in black elm with top in glossy glass Bordeaux. Soori coffee table in metal with antique bronze finish. Carpet Frame perla. In the background: Quid open display cases in black elm and moka mat lacquered shelves. Canapa glossy lacquered Dama coffee table.



In questa pagina: poltrona Jane rivestimento sfoderabile in tessuto Orleans 12 carbone e basamento in rovere spessart. Nella pagina successiva: divano Jane rivestimento non sfoderabile in pelle Nabuk 01 latte e basamento in brown nickel lucido.

This page: Jane armchair with removable cover in fabric Orleans 12 carbone and base in spessart oak. Next page: Jane sofa with non-removable cover in leather Nabuk 01 latte and glossy brown nickel base.







In questa pagina: poltrona Jane rivestimento non sfoderabile in pelle Soft 10 prugna e basamento in brown nickel lucido. Nella pagina successiva: poltrone Jane rivestimento sfoderabile in tessuto Skyros 02 oliva e basamento in brown nickel lucido. Tavolino Tridente con piano in marmo lucido noir saint laurent, struttura e cornice piano in olmo nero.

This page: Jane armchair with non-removable cover in leather Soft 10 prugna and glossy brown nickel base. Next page: Jane armchairs with removable cover in fabric Skyros 02 oliva and glossy brown nickel base. Tridente coffee table with top in glossy marble noir saint laurent, structure and frame of the top in black elm.





JANE

Design Emmanuel Gallina, 2017

Scocca e seduta in poliuretano flessibile stampato con parti in poliuretano flessibile a quote differenziate. Prerivestimento parti in tela cotone con piuma e parti in ovatta di poliestere accoppiata. Rivestimento in tessuto sfoderabile o in pelle non sfoderabile. Basamento e gambe in massello, finitura rovere spessart o olmo nero. Basamento e gambe in metallo verniciato brown nickel opaco o lucido. Cuscino salvareni opzionale, solo per divano, rivestimento sfoderabile in tessuto o pelle.

Body and seat in flexible moulded polyurethane with parts in multi-density flexible polyurethane. Pre-cover with parts in cotton cloth and parts in polyester padding. Cover in removable fabric or in non-removable leather. Base and legs in solid wood, finish spessart oak or black elm. Base and legs in mat or glossy brown nickel painted metal. Optional lower back cushion, available only for the sofa, with removable cover in fabric or leather.

Basamento essenza Wooden base

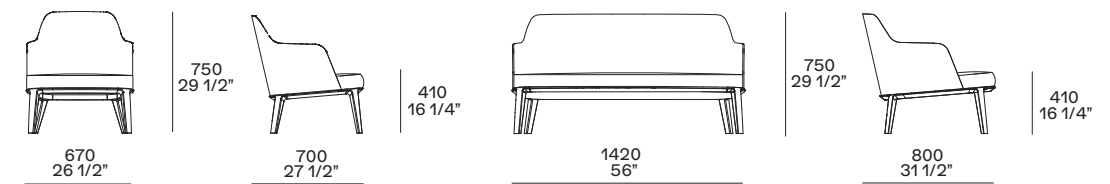

Basamento metallo Metal base

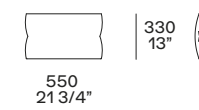
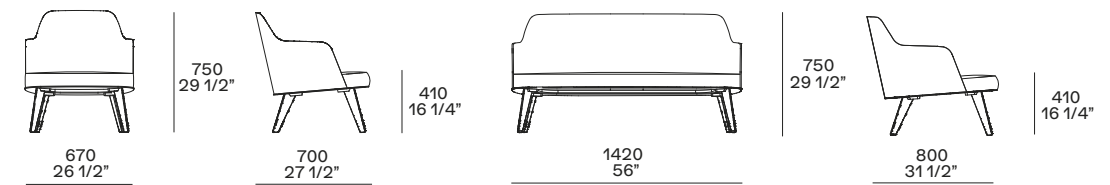

cuscino salvareni per divano
kidneyrest cushion for sofa



Nella pagina precedente: poltrone Jane Large rivestimento sfoderabile in tessuto Kitami 04 sabbia e basamento in olmo nero. Day Bed Bellport rivestimento sfoderabile in pelle Nabuk 08 prussia e piedini con profilo in brown nickel opaco. Tavolini Soori in metallo con finitura bronzo anticato. Quid bacheche a giorno con struttura e schienali in olmo nero, ripiani in olmo nero e in vetro, boiserie centrale in laccato metallico ottone, luce led integrata. In questa pagina: poltrona Jane Large e pouf rivestimento sfoderabile in tessuto Sendai 03 fango e basamento in olmo nero. Poltrona con bordura gros-grain nero.

Previous page: Jane Large armchairs with removable cover in fabric Kitami 04 sabbia and black elm base. Bellport Day Bed with removable cover in leather Nabuk 03 prussia and feet with profile in mat brown nickel. Soori coffee table in metal with antique bronze finish. Quid open display cases with structure and backs in black elm, shelves in black elm and in glass, central wall panelling in metal lacquer ottone, integrated led light. This page: Jane Large armchair and pouf with removable cover in fabric Sendai 03 fango and black elm base. Armchair with border in grosgrain nero.





In questa pagina: poltrona Jane Large rivestimento non sfoderabile, esterno in pelle Soft 08 visone, interno in tessuto Nayoro 02 sabbia e basamento in olmo nero. Nella pagina successiva: poltrona Jane Lounge e pouf Jane rivestimento non sfoderabile in pelle Nabuk 09 ruggine e basamento in olmo nero. Tavolino Soori finitura bronzo anticato. Bacheche a giorno Quid con struttura in olmo nero, schienali laccato lucido corda, ripiani in olmo nero e in vetro.

This page: Jane Large armchair with non-removable cover, outer cover in leather Soft 08 visone, inner cover in fabric Nayoro 02 sabbia and base in black elm. Previous page: Jane Lounge armchair and Jane pouf with non-removable in leather Nabuk 09 ruggine and black elm base. Soori coffee table with antique bronze finish. Open display cases Quid with structure in black elm, corda glossy lacquered backs, shelves in black elm and in glass.





JANE LARGE

Design Emmanuel Gallina, 2018

Scocca e seduta in poliuretano flessibile stampato con parti in poliuretano flessibile a quote differenziate. Prerivestimento in fibra di poliestere, piuma e tela cotone. Rivestimento in tessuto sfoderabile o in pelle non sfoderabile. Bordura gros-grain solo per rivestimento in tessuto Sendai. Possibilità di rivestimento diverso tra interno ed esterno della scocca con rivestimento sfoderabile ma non lavabile. Basamento e gambe in massello, finitura rovere spessart o olmo nero. Pouf Jane con seduta in poliuretano flessibile a quote differenziate, prerivestimento in fibra di poliestere. Rivestimento in tessuto sfoderabile o in pelle non sfoderabile. Basamento e gambe in massello, finitura rovere spessart o olmo nero.

Body and seat in flexible moulded polyurethane with parts in multi-density flexible polyurethane. Pre-cover in polyester fibre, feather and cotton cloth. Cover in removable fabric or in non-removable leather. Grosgrain border available only for cover in fabric Sendai. The inner and outer cover of the body can be in two different materials, the cover is removable but not washable. Base and legs in solid wood finish spessart oak or black elm. Jane pouf with seat in multi-density flexible polyurethane, pre-cover in polyester fibre. Cover in removable fabric or in non-removable leather. Base and legs in solid wood finish spessart oak or black elm.

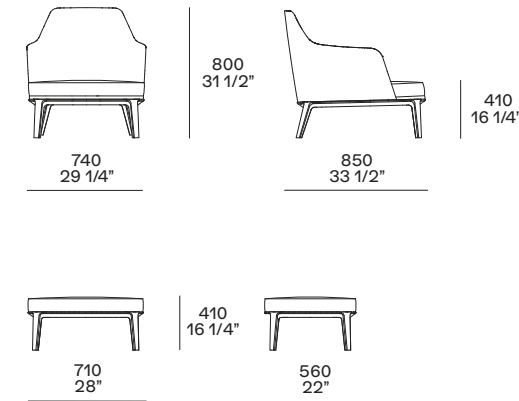

In questa pagina: poltrona Jane Lounge rivestimento non sfoderabile in pelle Soft 14 oliva e basamento in olmo nero. Quid contenitori a terra con ante complanari e top in olmo nero, profilo ante brown nickel opaco. Mensole a muro Wall System in laccato opaco canapa.

This page: Jane Lounge armchair with non-removable cover in leather Soft 14 oliva and base in black elm. Floorstanding storage units Quid with coplanar doors and top in black elm, door profile in mat brown nickel. Wall mounted shelves Wall System mat lacquered canapa.



In questa pagina: poltrona Jane Lounge rivestimento non sfoderabile in pelle Nabuk 09 ruggine e basamento in olmo nero.

This page: Jane Lounge armchair with non-removable cover in leather Nabuk 09 ruggine and base in black elm.



In questa pagina: poltrona Jane Lounge rivestimento sfoderabile in tessuto Sparta 21 arena e basamento in olmo nero.

This page: Jane Lounge armchair with removable cover in fabric Sparta 21 arena and base in black elm.





JANE LOUNGE

Design Emmanuel Gallina, 2018

Scocca e seduta in poliuretano flessibile stampato con parti in poliuretano flessibile a quote differenziate. Prerivestimento in fibra di poliestere, piuma e tela cotone. Rivestimento in tessuto sfoderabile o in pelle non sfoderabile. Bordura gros-grain solo per rivestimento in tessuto Sendai. Possibilità di rivestimento diverso tra interno ed esterno della scocca con rivestimento sfoderabile ma non lavabile. Basamento e gambe in massello, finitura rovere spessart o olmo nero. Pouf Jane con seduta in poliuretano flessibile a quote differenziate, prerivestimento in fibra di poliestere. Rivestimento in tessuto sfoderabile o in pelle non sfoderabile. Basamento e gambe in massello, finitura rovere spessart o olmo nero.

Body and seat in flexible moulded polyurethane with parts in multi-density flexible polyurethane. Pre-cover in polyester fibre, feather and cotton cloth. Cover in removable fabric or in non-removable leather. Grosgrain border available only for cover in fabric Sendai. The inner and outer cover of the body can be in two different materials, the cover is removable but not washable. Base and legs in solid wood finish spessart oak or black elm. Jane pouf with seat in multi-density flexible polyurethane, pre-cover in polyester fibre. Cover in removable fabric or in non-removable leather. Base and legs in solid wood finish spessart oak or black elm.

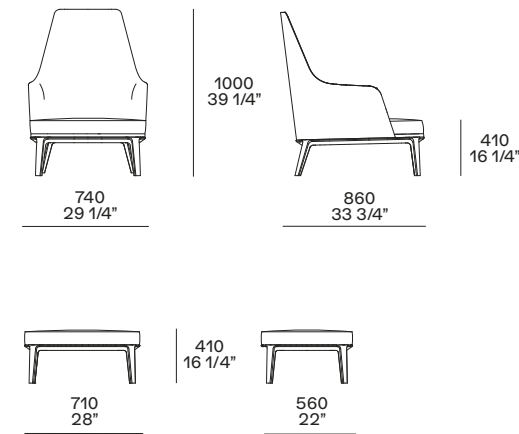



MAD COLLECTION

La collezione Mad si è evoluta a partire da Mad Chair, una poltrona dalle linee armoniche e avvolgenti, cui si sono aggiunte la poltrona con schienale alto e basamento girevole Mad Joker e la poltrona bassa Mad Queen, morbida e rassicurante. A completare la collezione disegnata da Marcel Wanders, Mad King e Mad Chaise Longue, due poltrone dal disegno asimmetrico, sinuose e invitanti.

The Mad collection has evolved starting from Mad Chair, an armchair with harmonious and enveloping lines, later accompanied by the armchair with high back and swivel base Mad Joker and the low Mad Queen armchair, soft and reassuring. To complete the collection designed by Marcel Wanders, Mad King and Mad Chaise Longue, two armchairs with an asymmetric design, sinuous and inviting.





Nella pagina precedente: poltrone Mad Chair rivestimento sfoderabile in velluto Persia 1404 carbone, gambe in rovere spessart. Pouf Onda in velluto sfoderabile Persia 1403 ocra. Tavolino Bristol in rovere spessart. In questa pagina: poltrone Mad Chair rivestimento sfoderabile in tessuto Zante 07 oliva, basamento girevole in brown nickel lucido. Tavolino Soori in metallo finitura bronzo anticato. Tavolino Dama laccato lucido granata. Tappeto Frame perla.

Previous page: Mad Chair armchairs with removable cover in velvet Persia 1404 carbone, legs in spessart oak. Onda pouf in removable velvet Persia 1403 ocra. Bristol coffee table in spessart oak. This page: Mad Chair armchairs with removable cover in fabric Zante 07 oliva, swivel base in glossy brown nickel. Soori coffee table in metal with antique bronze finish. Granata glossy lacquered Dama coffee table. Carpet Frame perla.



In questa pagina: poltrona Mad Chair rivestimento sfoderabile in tessuto Zante 10 nero, gambe in olmo nero.

This page: Mad Chair armchair with removable cover in fabric Zante 10 nero, legs in black elm.





In questa pagina: poltrona Mad Chair rivestimento sfoderabile in vel-
luto Persia 2006 prugna, basamento girevole in brown nickel lucido.

This page: Mad Chair armchair with removable cover in velvet Persia
2006 prugna, swivel base in glossy brown nickel.



In questa pagina: poltrone Mad Chair con cuscino salvareni, rivestimento sfoderabile in velluto Persia 1404 carbone, gambe in rovere spessart. Divano Bristol rivestimento sfoderabile in tessuto Oxford 02 castoro. Tavolini Bristol retro divano e laterale in laccato lucido visone con inserti e piedini in brown nickel opaco. Tavolino Bigger in rovere spessart con piano in marmo grigio stardust levigato.

This page: Mad Chair armchairs with lower back cushion, removable cover in velvet Persia 1404 carbone, legs in spessart oak. Bristol sofa with removable cover in fabric Oxford 02 castoro. Bristol small tables to the back and to the side of the sofa glossy lacquered visone with inlays and feet in mat brown nickel. Bigger coffee table in spessart oak with top in mat marble grigio stardust.



In questa pagina: poltrona Mad Chair rivestimento sfoderabile in pelle Soft 14 oliva, basamento girevole in brown nickel lucido.

This page: Mad Chair armchair with removable cover in leather Soft 14 oliva, swivel base in glossy brown nickel.





In questa pagina: poltrona Mad Chair rivestimento sfoderabile in pelle Cashmere bianco, gambe in rovere cenere. Nella pagina successiva: poltrone Mad Chair rivestimento sfoderabile in pelle Cashmere grigio con basamento girevole in brown nickel lucido. Tavolino Soori in metallo finitura bronzo anticato. Tappeto Frame carbone.

This page: Mad Chair armchair with removable cover in leather Cashmere bianco, legs in cenere oak. Next page: Mad Chair armchairs with removable cover in leather Cashmere grigio with swivel base in glossy brown nickel. Soori coffee table in metal with antique bronze finish. Carpet Frame carbone.





MAD CHAIR

Design Marcel Wanders, 2014

Scocca in poliuretano flessibile stampato, prerivestimento in fibra di poliestere. Rivestimento sfoderabile in tessuto o pelle. Possibilità di rivestimento diverso tra interno ed esterno della scocca, in questa versione il rivestimento non è sfoderabile. Il rivestimento Gibson matelassé è disponibile solo per la scocca interna. Gambe in rovere spessart, rovere cenere e olmo nero o basamento girevole con ritorno in metallo verniciato brown nickel opaco o lucido. Cuscino salvareni opzionale con rivestimento sfoderabile in tessuto o pelle.

Body in flexible moulded polyurethane, pre-cover in polyester fibre. Removable cover in fabric or leather. The inner and outer cover of the body can be in two different materials; in this version, the cover is not removable. Fabric Gibson matelassé is available only for the inner cover. Legs in spessart oak, cenere oak or black elm or base with automatic returning mechanism in mat or glossy brown nickel painted metal. Optional lower back cushion with removable cover in fabric or leather.

Gambe in essenza Legs in wood

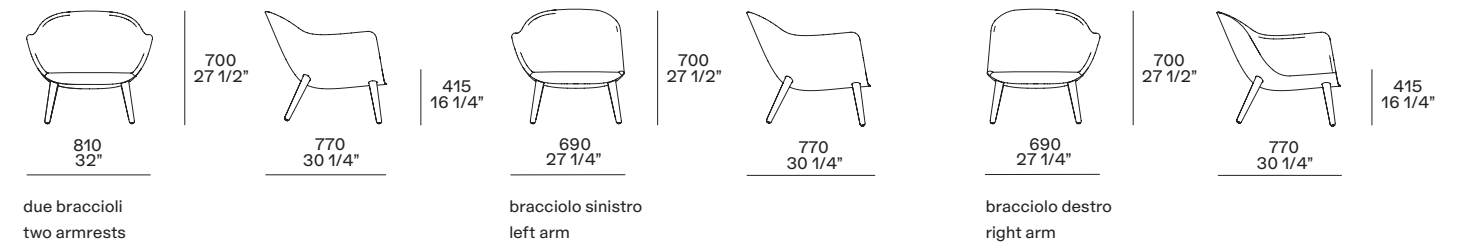

Basamento girevole Swivel base

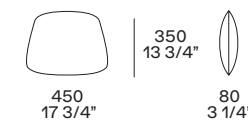
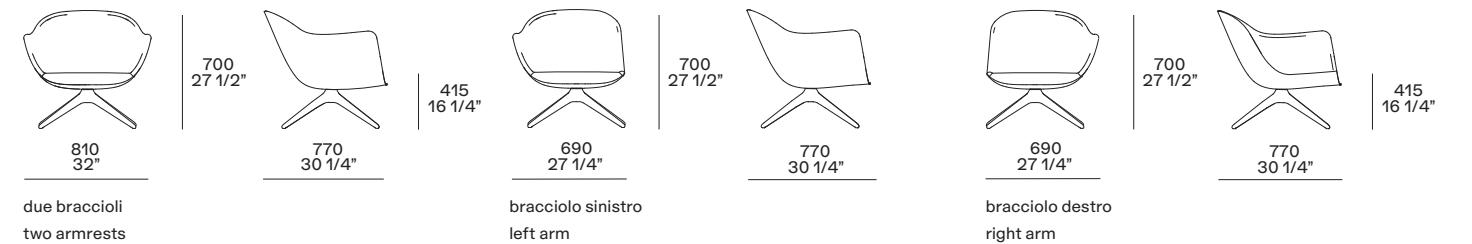

cuscino salvareni
kidneyrest cushion



Nella pagina precedente: poltrone Mad Joker e pouf Mad rivestimento non sfoderabile, esterno in pelle Soft 14 oliva e interno in tessuto Zante 07 oliva, basamento girevole in brown nickel lucido. Tavolini Dama in massello noce canaletto. Tappeto Plain natural. In questa pagina: poltrona Mad Joker e pouf Mad rivestimento non sfoderabile, esterno in pelle Nabuk 02 tortora e interno in tessuto Argo 1001 bianco, basamento girevole in brown nickel lucido.

Previous page: Mad Joker armchairs and Mad pouf with non-removable cover, outer cover in leather Soft 14 oliva and inner cover in fabric Zante 07 oliva, swivel base in glossy brown nickel. Dama coffee tables in solid walnut Canaletto. Carpet Plain natural. This page: Mad Joker armchair and Mad pouf with non-removable cover, outer cover in leather Nabuk 02 tortora and inner cover in fabric Argo 1001 bianco, swivel base in glossy brown nickel.





In questa pagina: poltrona Mad Joker rivestimento non sfoderabile, esterno in tessuto Norway 03 nero e interno in tessuto Sendai 04 lavagna, gambe in olmo nero. Nella pagina successiva: poltrona Mad Joker rivestimento non sfoderabile, esterno in pelle Soft 14 oliva e interno in tessuto Argo 1004 cenere, basamento girevole in brown nickel lucido. Quid boiserie in olmo nero con mensole laccato opaco piombo e cuoio 28 avorio. Pouf Mondrian rivestimento sfoderabile in tessuto Olimpia 11 polvere. Tappeto Frame grey.

This page: Mad Joker armchair covered in non-removable fabric, outer cover in fabric Norway 03 nero and inner cover in fabric Sendai 04 lavagna, legs in black elm. Next page: Mad Joker armchair with non-removable cover, outer cover in leather Soft 14 oliva and inner cover in fabric Argo 1004 cenere, swivel base in glossy brown nickel. Quid wall panelling in black elm with piombo mat lacquered shelves and hide 28 avorio. Mondrian pouf with removable cover in fabric Olimpia 11 polvere. Carpet Frame grey.





MAD JOKER

Design Marcel Wanders, 2016

Poltrona con scocca in poliuretano flessibile stampato, prerivestimento in fibra di poliestere. Rivestimento non sfoderabile in tessuto o pelle. Possibilità di rivestimento diverso tra interno ed esterno della scocca. Gambe in rovere spessart, rovere cenere e olmo nero o basamento girevole con ritorno in metallo verniciato brown nickel opaco o lucido.

Pouf Mad con seduta in poliuretano flessibile stampato, prerivestimento in fibra di poliestere. Rivestimento sfoderabile in tessuto o pelle. Possibilità di rivestimento diverso tra interno ed esterno della scocca, in questa versione il rivestimento non è sfoderabile. Basamento fisso in metallo verniciato brown nickel opaco o lucido.

Armchair with body in flexible moulded polyurethane, pre-cover in polyester fibre. Non-removable cover in fabric or leather. The inner and outer cover of the body can be in two different materials.

Legs in spessart oak, cenere oak and black elm or base with automatic returning mechanism in mat or glossy brown nickel painted metal.

Mad pouf with seat in flexible moulded polyurethane, pre-cover in polyester fibre. Removable cover in fabric or leather. The inner and outer cover of the body can be in two different materials; in this version, the cover is not removable. Fixed base in mat or glossy brown nickel painted metal.

Gambe in essenza Legs in wood

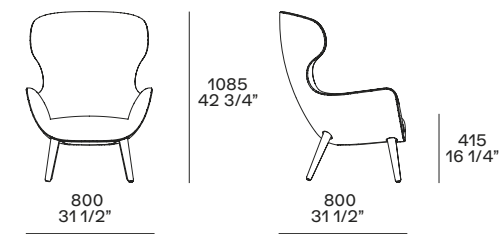

Basamento girevole Swivel base

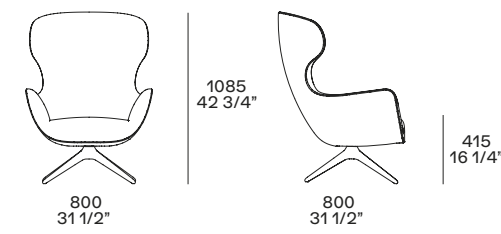

Pouf basamento fisso Pouf with fixed base

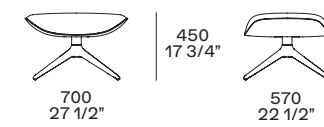



Nella pagina precedente: poltrone Mad Queen rivestimento non sfoderabile, esterno e gambe in pelle Nabuk 01 latte, interno in tessuto Norway 08 avorio. Tavolino Mad Coffee Table in olmo nero con piano in marmo calacatta oro levigato. In questa pagina: poltrona Mad Queen rivestimento non sfoderabile, esterno in pelle Soft 14 oliva e interno in tessuto Zante 07 oliva, gambe in olmo nero.

Previous page: Mad Queen armchairs with non-removable cover, outer cover and legs in leather Nabuk 01 latte, inner cover in fabric Norway 08 avorio. Mad coffee table in black elm with top in mat marble calacatta oro. This page: Mad Queen armchair with non-removable cover, outer cover in leather Soft 14 oliva and inner cover in fabric Zante 07 oliva, legs in black elm.





In questa pagina: poltrone Mad Queen rivestimento non sfoderabile in tessuto Merida 14 latte, gambe in rovere cenere. Nella pagina successiva: poltrona Mad Queen rivestimento non sfoderabile, esterno in tessuto Norway 03 nero e interno in tessuto Gibson matelassé 07 grafite, gambe in rovere cenere. Tavolini Mad Coffee Table in olmo nero con piani in olmo nero e in marmo grigio stardust levigato.

This page: Mad Queen armchairs with non-removable cover in fabric Merida 14 latte, legs in cenere oak. Next page: Mad Queen armchair with non-removable cover, outer cover in fabric Norway 03 nero and inner cover in fabric Gibson matelassé 07 grafite, legs in cenere oak. Mad coffee tables in black elm with top in black elm and in mat marble grigio stardust.





MAD QUEEN

Design Marcel Wanders, 2015

Scocca e seduta in poliuretano flessibile stampato, prerivestimento in fibra di poliestere. Rivestimento non sfoderabile in tessuto o pelle. Possibilità di rivestimento diverso tra interno ed esterno della scocca. Il rivestimento Gibson matelassé è disponibile solo per la scocca interna. Gambe in rovere spessart, rovere cenere e olmo nero o rivestite come l'esterno della scocca.

Body and seat in flexible moulded polyurethane, pre-cover in polyester fibre. Non-removable cover in fabric or leather. The inner and outer cover of the body can be in two different materials. Fabric Gibson matelassé is available only for the inner cover. Legs in spessart oak, cenere oak or black elm, or in the same material of the outer cover.

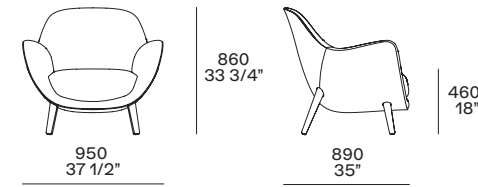





MAD CHAISE LONGUE

Design Marcel Wanders, 2016

Scocca e seduta in poliuretano flessibile stampato, prerivestimento in fibra di poliestere. Rivestimento non sfoderabile in tessuto o pelle. Possibilità di rivestimento diverso tra interno ed esterno della scocca. Il rivestimento Gibson matelassé è disponibile solo per la scocca interna. Gambe in rovere spessart, rovere cenere e olmo nero o rivestite come l'esterno della scocca.

Body and seat in flexible moulded polyurethane, pre-cover in polyester fibre. Non-removable cover in fabric or leather. The inner and outer cover of the body can be in two different materials. Fabric Gibson matelassé is available only for the inner cover. Legs in spessart oak, cenere oak or black elm or in the same material of the outer cover.

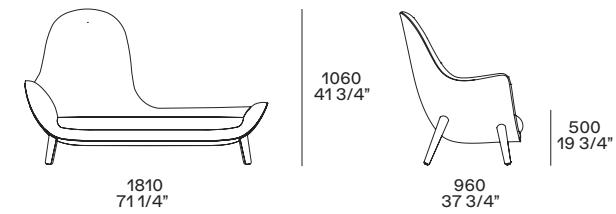

Qui e nella pagina precedente: Mad Chaise Longue rivestimento non sfoderabile, esterno in pelle Nabuk 08 prussia, interno in tessuto Kushiro 11 notte, gambe in olmo nero.

This and previous page: Mad Chaise Longue with non-removable cover, outer cover in leather Nabuk 08 prussia, inner cover in fabric Kushiro 11 notte, black elm legs.

In questa pagina: poltrona Mad King rivestimento non sfoderabile, esterno in tessuto Merida 07 porpora e interno in tessuto Gibson matelassé 23 rubino, gambe e vassoio opzionale in rovere cenere. Pouf Elise rivestimento non sfoderabile in pelle Nabuk 01 latte. A parete bacheca Quid laccato opaco piombo con schienali laccato opaco carbone, cassetti in cuoio 02 nero e ripiani laccato opaco piombo.

This page: Mad King armchair with non-removable cover, outer cover in fabric Merida 07 porpora and inner cover in fabric Gibson matelassé 23 rubino, legs and optional tray in cenere oak. Elise pouf with non-removable cover in leather Nabuk 01 latte. Wall mounted Quid open display case mat lacquered piombo with carbone mat lacquered backs, drawers in hide 02 nero and piombo mat lacquered shelves.



In questa pagina: poltrona Mad King rivestimento non sfoderabile, esterno e gambe in pelle Soft 06 cemento, interno in tessuto Kitami 03 acciaio.

This page: Mad King armchair with non-removable cover, outer cover and legs in leather Soft 06 cemento, inner cover in fabric Kitami 03 acciaio.





In questa pagina: poltrona Mad King rivestimento non sfoderabile, esterno in pelle Nabuk 01 latte, interno in tessuto Itaca 309 cipria, gambe in rovere cenere. Nella pagina successiva: dettaglio del vassoio opzionale per la versione Mad King con un bracciolo. Poltrona Mad King rivestimento non sfoderabile, esterno in tessuto Merida 07 porpora e interno in tessuto Gibson matelassé 23 rubino, gambe e vassoio in rovere cenere.

This page: Mad King armchair with non-removable cover, outer cover in leather Nabuk 01 latte, inner cover in fabric Itaca 309 cipria, cenere oak legs. Next page: close up of the optional tray for the version Mad King with one armrest. Mad King armchair with non-removable cover, outer cover in fabric Merida 07 porpora and inner cover in fabric Gibson matelassé 23 rubino, legs and tray in cenere oak.





MAD KING
Design Marcel Wanders, 2015

Scocca e seduta in poliuretano flessibile stampato, prerivestimento in fibra di poliestere. Rivestimento non sfoderabile in tessuto o pelle. Possibilità di rivestimento diverso tra interno ed esterno della scocca. Il rivestimento Gibson matelassé è disponibile solo per la scocca interna. Per la versione con un bracciolo è disponibile un vassoio opzionale in rovere spessart, rovere cenere o olmo nero. Gambe in rovere spessart, rovere cenere e olmo nero o rivestite come l'esterno della scocca.

Body and seat in flexible moulded polyurethane, pre-cover in polyester fibre. Non-removable cover in fabric or leather. The inner and outer cover of the body can be in two different materials. Fabric Gibson matelassé is available only for the inner cover. For the version with one armrest an optional tray in spessart oak, cenere oak or black elm is available. Legs in spessart oak or black elm or in the same material of the outer cover.

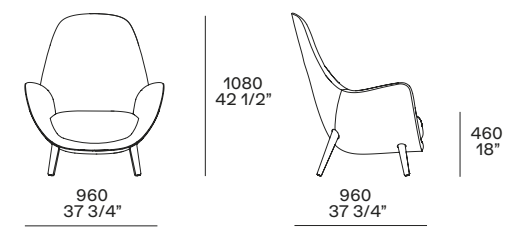

due braccioli
two armrests

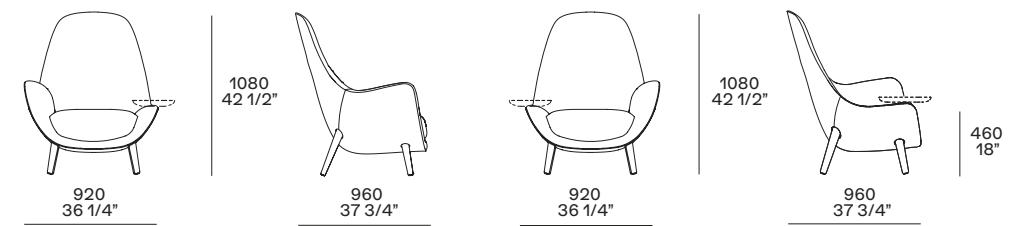

bracciolo sinistro
left arm

bracciolo destro
right arm

STANFORD COLLECTION

Sintesi e leggerezza sono i capisaldi della naturale eleganza della collezione Stanford. Sulla base girevole in metallo si ergono linee rigorose, che si smussano nella poltrona con schienale alto Stanford Lounge. Particolare il rivestimento, con esterno in cuoio e interno in pelle tono su tono, con cuscino di seduta in pelle.

Synthesis and lightness are the cornerstones of the natural elegance of the Stanford collection. On the swivel metal base stand rigorous lines, which get smoothed in the high-back armchair Stanford Lounge. The padding is particular, with hard leather exterior and tone-on-tone leather interior, with leather seat cushion.





Nella pagina precedente: poltrona Stanford rivestimento non sfoderabile, esterno in cuoio 26 invecchiato, interno e cuscino della seduta in pelle Soft 04 cognac, basamento girevole in brown nickel lucido. Tavolino Mondrian piano in marmo lucido noir saint laurent e struttura in fusione di bronzo lucidata oro. Tappeto Frame grey. In questa pagina: poltrona Stanford rivestimento non sfoderabile in tessuto Orleans 12 carbone, basamento girevole in brown nickel lucido. Tavolino Soori in metallo finitura bronzo anticato.

Previous page: Stanford armchair with non-removable cover, outer cover in hide 26 invecchiato, inner cover and seat cushion in leather Soft 04 cognac, swivel base in glossy brown nickel. Mondrian coffee table with top in glossy marble noir saint Laurent and structure in gold polished bronze casting. Carpet Frame grey. This page: Stanford armchair with non-removable cover in fabric Orleans 12 carbone, swivel base in glossy brown nickel. Soori coffee table in metal with antique bronze finish.



In questa pagina: poltrona Stanford rivestimento non sfoderabile, esterno in cuoio 02 nero, interno e cuscino della seduta in pelle Soft 13 carbone, basamento girevole in brown nickel lucido. Cuscino poggiatesta opzionale rivestimento non sfoderabile in pelle Soft 13 carbone.

This page: Stanford armchair with non-removable cover, outer cover in hide 02 nero, inner cover and seat cushion in leather Soft 13 carbone, swivel base in glossy brown nickel. Optional lower back cushion with non-removable cover in leather Soft 13 carbone.





In questa pagina: poltrona Stanford rivestimento non sfoderabile, esterno in cuoio 29 tortora, interno e cuscino della seduta in pelle Soft 02 mastice, basamento girevole in brown nickel lucido. Nella pagina successiva: poltrone Stanford rivestimento non sfoderabile, esterno in cuoio 26 invecchiato, interno e cuscino seduta in pelle Soft 04 cognac, basamento girevole in brown nickel lucido. Tappeto Frame grey.

This page: Stanford armchair with non-removable cover, outer cover in hide 29 tortora, inner cover and seat cushion in leather Soft 02 mastice, swivel base in glossy brown nickel. Next page: Stanford armchairs with non-removable cover, outer cover in hide 26 invecchiato, inner cover and seat cushion in leather Soft 04 cognac, swivel base in glossy brown nickel. Carpet Frame grey.





STANFORD

Design Jean-Marie Massaud, 2016

Scocca in poliuretano compatto con inserto parte interna in poliuretano flessibile. Sottosedile in poliuretano compatto, cuscino seduta in poliuretano flessibile a quote differenziate e pririvestimento in ovatta di poliestere. Rivestimento non sfoderabile in tessuto, pelle o esterno scocca e sottosedile in cuoio, interno scocca e cuscino seduta in pelle Soft. Basamento girevole in fusione d'alluminio verniciato brown nickel opaco o lucido. Cuscino salvareni opzionale, rivestimento sfoderabile in tessuto e non sfoderabile in pelle.

Body in compact polyurethane with inlay in flexible polyurethane. Seat in compact polyurethane with seat cushion in multi-density flexible polyurethane, pre-cover in polyester padding. Non-removable cover in fabric, leather or outer body and seat in hide, inner body and seat cushion in leather Soft. Swivel base in aluminium casting painted mat or glossy brown nickel. Optional lower back cushion, removable cover in fabric and non-removable cover in leather.

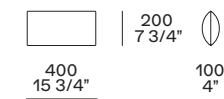
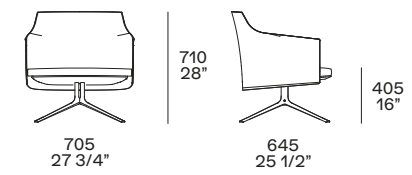

cuscino salvareni
kidneyrest cushion

In questa pagina: poltrone Stanford Lounge rivestimento non sfoderabile, esterno in cuoio 02 nero, interno e cuscino della seduta in pelle Soft 13 carbone, basamento girevole in brown nickel lucido. Tavolino Soori in metallo finitura bronzo anticato. Tappeto Plain natural.

This page: Stanford Lounge armchairs with non-removable cover, outer cover in hide 02 nero, inner cover and seat cushion in leather Soft 13 carbone, swivel base in glossy brown nickel. Soori coffee table in metal with antique bronze finish. Carpet Plain natural.



In questa pagina: poltrona Stanford Lounge rivestimento non sfoderabile, esterno in cuoio 19 caffè, interno e cuscino della seduta in pelle Soft 12 moka, basamento girevole in brown nickel lucido.

This page: Stanford Lounge armchair with non-removable cover, outer cover in hide 19 caffè, inner cover and seat cushion in leather Soft 12 moka, swivel base in glossy brown nickel.





In questa pagina: poltrona Stanford Lounge rivestimento non sfoderabile, esterno in cuoio 38 oliva, interno e cuscino della seduta in pelle Soft 14 oliva, basamento girevole in brown nickel opaco. Cuscino poggiatesta opzionale rivestimento non sfoderabile in pelle Soft 14 oliva. Nella pagina successiva: poltrona Stanford Lounge rivestimento non sfoderabile, esterno in cuoio 02 nero, interno e cuscino della seduta in pelle Soft 13 carbone. Tappeto Plain natural.

This page: Stanford Lounge armchair with non-removable cover, outer cover in hide 38 oliva, inner cover and seat cushion in leather Soft 14 oliva, swivel base in mat brown nickel. Optional lower back cushion with non-removable cover in leather Soft 14 oliva. Next page: Stanford Lounge armchair with non-removable cover, outer cover in hide 02 nero, inner cover and seat cushion in leather Soft 13 carbone. Carpet Plain natural.

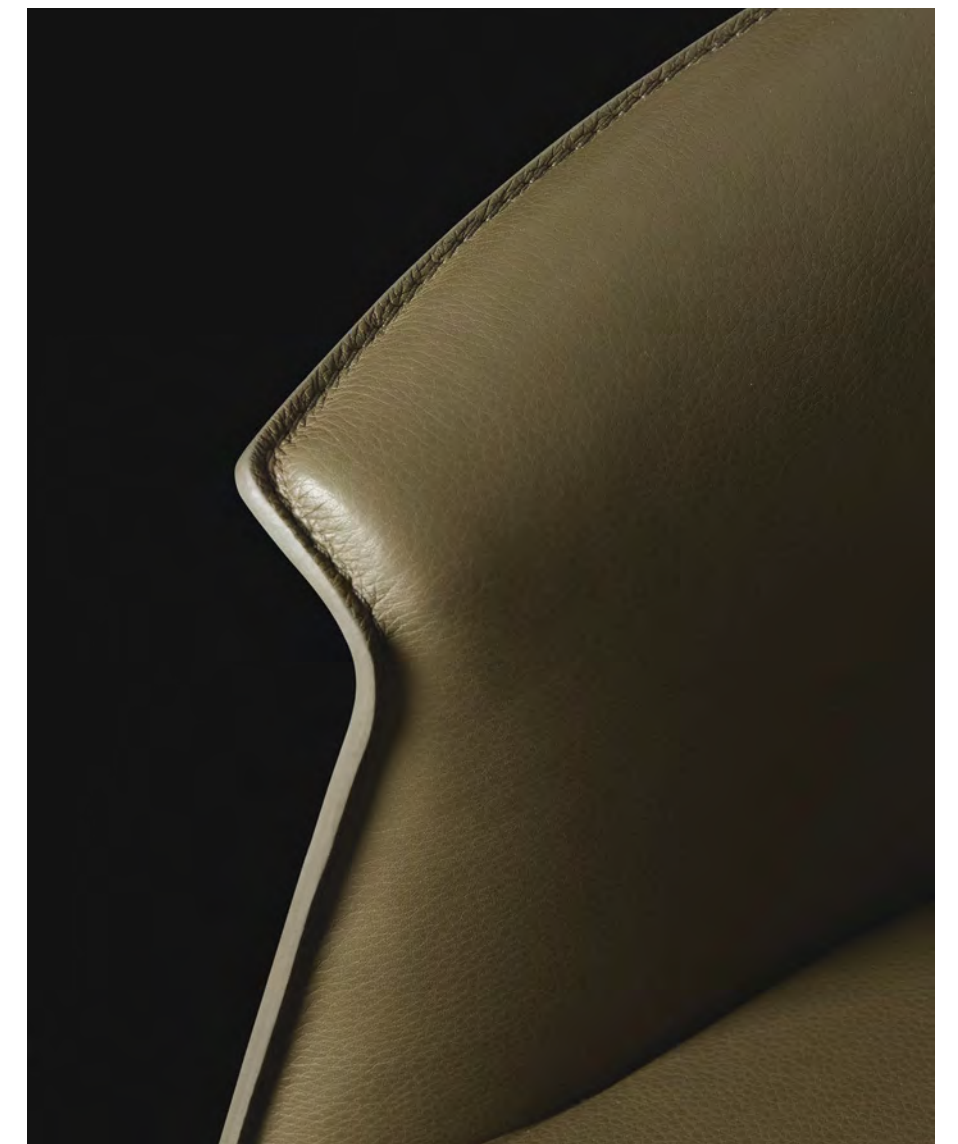



STANFORD LOUNGE

Design Jean-Marie Massaud, 2016

Scocca in poliuretano compatto con inserto parte interna in poliuretano flessibile. Sottosedile in poliuretano compatto, cuscino seduta in poliuretano flessibile a quote differenziate e pririvestimento in ovatta di poliestere. Rivestimento non sfoderabile in tessuto, pelle o esterno scocca e sottosedile in cuoio, interno scocca e cuscino seduta in pelle Soft. Basamento girevole in fusione d'alluminio verniciato brown nickel opaco o lucido. Cuscino salvareni opzionale, rivestimento sfoderabile in tessuto e non sfoderabile in pelle.

Body in compact polyurethane with inlay in flexible polyurethane. Seat in compact polyurethane with seat cushion in multi-density flexible polyurethane, pre-cover in polyester padding. Non-removable cover in fabric, leather or outer body and seat in hide, inner body and seat cushion in leather Soft. Swivel base in aluminium casting painted mat or glossy brown nickel. Optional lower back cushion, removable cover in fabric and non-removable cover in leather.

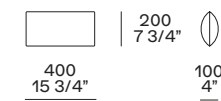
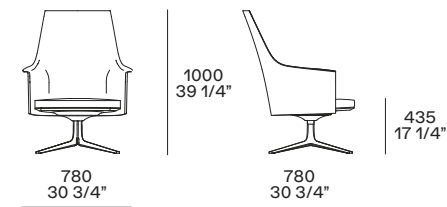

cuscino salvareni
kidneyrest cushion

SANTA MONICA COLLECTION

La poltrona Santa Monica ha forme avvolgenti e confortevoli, dettagli sartoriali e diversi rivestimenti disponibili, in pelle o tessuto. La sua raffinatezza si sostanzia anche nella versione Lounge, con schienale alto e pouf coordinato, e nella Santa Monica Home, con poggiatesta.

The Santa Monica armchair has enveloping and comfortable shapes, tailored details, and several coverings available, in leather or fabric. Its refinement is also confirmed in the Lounge version, with high back and coordinated pouf, and in the Santa Monica Home, with headrest.



Nella pagina precedente: poltrone Santa Monica rivestimento sfoderabile in pelle Nabuk 02 tortora e cucitura normale doppia. Tavolino Soori in metallo finitura bronzo anticato. In questa pagina: poltrona Santa Monica rivestimento sfoderabile in pelle Nabuk 02 tortora e cucitura normale doppia.

Previous page: Santa Monica armchairs with removable cover in leather Nabuk 02 tortora and normal double stitching. Soori coffee table in metal with antique bronze finish. This page: Santa Monica armchair with removable cover in leather Nabuk 02 tortora and normal double stitching.





In questa pagina: poltrona Santa Monica rivestimento sfoderabile versione fondopiega in tessuto Olimpia 11 polvere, cuciture a cordoncino e bordure gros-grain nero. Nella pagina successiva: poltrona Santa Monica rivestimento sfoderabile in pelle Nabuk 02 tortora e cucitura normale doppia. Tavolino Soori in metallo finitura bronzo anticato.

This page: Santa Monica armchair with removable slipcover in fabric Olimpia 11 polvere, drawstring stitching and border in grosgrain nero. Next page: Santa Monica armchair with removable cover in leather Nabuk 02 tortora and normal double stitching. Soori coffee table in metal with antique bronze finish.





SANTA MONICA

Design Jean-Marie Massaud, 2011

Scocca e seduta in poliuretano flessibile stampato in doppia densità. Prerivestimento parti in tela cotone con interno in piuma e parti in fibra di poliestere accoppiata. Piedini in materiale plastico o base girevole.

Rivestimento versione tesato sfoderabile in tessuto o pelle. Rivestimento versione fondopiega sfoderabile in tessuto.

Versione in tessuto tesato o fondopiega con alamari. Cucitura normale doppia o a cordoncino con filato nei diversi colori da campionario (escluso rivestimento in pelle e velluto). Bordure gros-grain nei colori da campionario, solo per rivestimento versione fondopiega.

Body and seat in flexible moulded polyurethane with double density. Pre-cover with parts in cotton cloth with feather padding and parts with polyester fibre padding. Feet in plastic material or swivel base. Version with stretched cover removable in fabric and leather. Version with slipcover removable in fabric. Version with stretched fabric or slipcover with fasteners. Normal double stitching or drawstring stitching with yarn in the colours as per sample book (except for cover in leather and in velvet). Grosgrain border in the colours as per sample book, only for the version with slipcover.

Rivestimento tesato Stretched cover

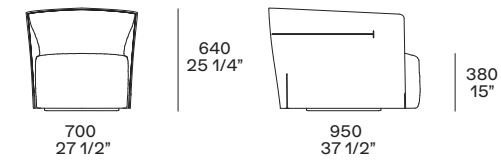

Rivestimento fondopiega Slipcover

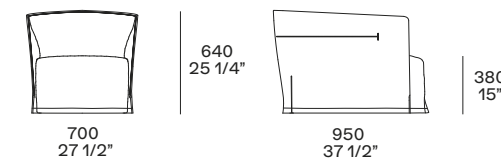



In questa pagina: poltrona e pouf Santa Monica Lounge rivestimento sfoderabile in tessuto Norway 06 sabbia e cuciture a cordoncino nero.

This page: armchair and pouf Santa Monica Lounge with removable cover in fabric Norway 06 sabbia and drawstring stitching nero.



In questa pagina: poltrona Santa Monica Lounge rivestimento sfoderabile in tessuto Sparta 16 ferro e cucitura normale doppia. Sotto: dettaglio degli alamari che caratterizzano la collezione Santa Monica con il rivestimento in tessuto sia nella versione tesata che con fondopiega.

This page: Santa Monica Lounge armchair with removable cover in fabric Sparta 16 ferro and normal double stitching. Below: close up of the fasteners distinguishing Santa Monica collection, both with stretched cover and with slipcover.



In questa pagina: poltrona e pouf Santa Monica Lounge rivestimento sfoderabile versione fondopiega in tessuto Lima 43 écreu, cuciture a cordoncino e bordure gros-grain sahara. Nella pagina successiva: poltrona Santa Monica Lounge rivestimento sfoderabile in tessuto Norway 06 sabbia e cuciture a cordoncino nero. Tavolino Ipsilon in rovere spessart.

This page: armchair and pouf Santa Monica Lounge with removable cover in the version with slipcover in fabric Lima 43 ecru, drawstring stitching and border in grosgrain sahara. Next page: Santa Monica Lounge armchair with removable cover in fabric Norway 06 sabbia and drawstring stitching nero. Ipsilon coffee table in spessart oak.





SANTA MONICA LOUNGE

Design Jean-Marie Massaud, 2012

Scocca e seduta in poliuretano flessibile stampato in doppia densità. Prerivestimento parti in tela cotone con interno in piuma e parti in fibra di poliestere accoppiata. Piedini poltrona e pouf in materiale plastico o base girevole solo per poltrona. Rivestimento versione tessuto sfoderabile in tessuto o pelle. Rivestimento versione fondopiega sfoderabile in tessuto. Versione in tessuto tessuto o fondopiega con alamari. Cucitura normale doppia o a cordoncino con filato nei diversi colori da campionario (escluso rivestimento in pelle e velluto). Bordure gros-grain nei colori da campionario, solo per rivestimento versione fondopiega.

Body and seat in flexible moulded polyurethane with double density. Pre-cover: parts in cotton cloth with feather padding and parts in polyester fibre. Armchair and pouf feet in plastic material or swivel base only for the armchair. Version with stretched cover removable in fabric and leather. Version with slipcover removable in fabric. Version with stretched fabric or slipcover with fasteners. Normal double stitching or drawstring stitching with yarn in the colours as per sample book (except for cover in leather and in velvet). Grosgrain border in the colours as per sample book, only for the version with slipcover.

Rivestimento tessuto Stretched cover

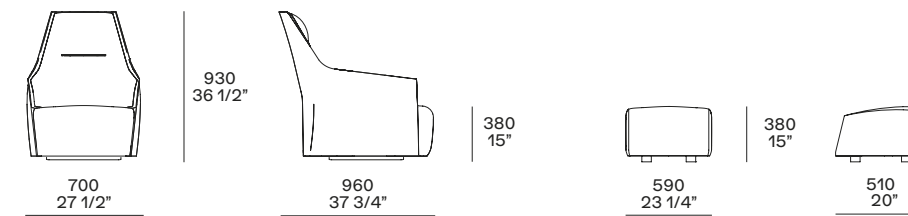

Rivestimento fondopiega Slipcover

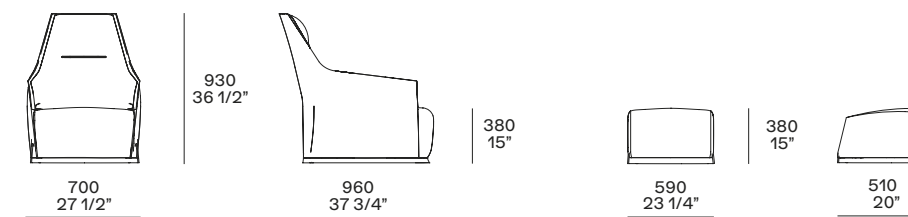



In questa pagina: poltrona Santa Monica Home rivestimento sfoderabile in tessuto Norway 19 prussia e cucitura normale doppia. Tavolino Tribeca in brown nickel opaco con piano in marmo emperador dark lucido. Sistema a giorno Wall System in rovere cenere, vetrine sporgenti Ghost in vetro trasparente riflettente con telaio verniciato ardesia e schienali laccato opaco caramello.

This page: Santa Monica Home armchair with removable cover in fabric Norway 19 prussia and normal double stitching. Tribeca coffee table in mat brown nickel with top in glossy marble emperador dark. Day system Wall System in cenere oak, jutting out showcases Ghost in transparent reflecting glass with ardesia painted frame and caramello mat lacquered backs.



In questa pagina: poltrona Santa Monica Home rivestimento sfoderabile in tessuto Merida 14 latte e cucitura normale doppia.

This page: Santa Monica Home armchair with removable cover in fabric Merida 14 latte and normal double stitching.





In questa pagina: poltrona Santa Monica Home rivestimento sfoderabile in tessuto Sparta 24 oceano e cucitura normale doppia. Nella pagina successiva: poltrona Santa Monica Home rivestimento sfoderabile in tessuto Norway 19 prussia e cucitura normale doppia. Tavolino Tribeca in brown nickel opaco con piano in marmo emperador dark lucido. Sistema a giorno Wall System in rovere cenere, vetrine sporgenti Ghost in vetro trasparente riflettente con telaio verniciato ardesia e schienali laccato opaco caramello.

This page: Santa Monica Home armchair with removable cover in fabric Sparta 24 oceano and normal double stitching. Next page: Santa Monica Home armchair with removable cover in fabric Norway 19 prussia and normal double stitching. Tribeca coffee table in mat brown nickel with top in glossy marble emperador dark. Day system Wall System in cenere oak, jutting out showcases in transparent reflecting glass with ardesia painted frame and caramello mat lacquered backs.





SANTA MONICA HOME

Design Jean-Marie Massaud, 2015

Scocca e seduta in poliuretano flessibile stampato, doppia densità per la seduta. Prerivestimento parti in tela cotone con interno in piuma e parti in fibra di poliestere accoppiata. Piedini in materiale plastico o base girevole. Rivestimento in tessuto sfoderabile o in pelle non sfoderabile. Cucitura normale doppia.

Body and seat in flexible moulded polyurethane, seat with double density. Pre-cover with parts in cotton cloth with feather padding and parts with polyester fibre padding. Feet in plastic material or swivel base. Cover in removable fabric or in non-removable leather. Normal double stitching.

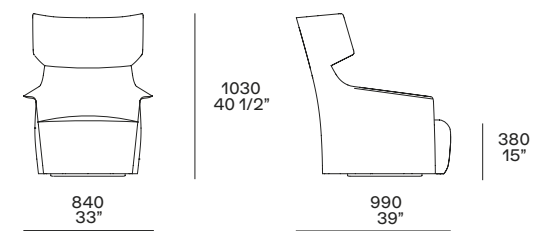



BELLPORT

Dell'omonima serie disegnata da Jean-Marie Massaud fa parte anche la poltrona Bellport, caratterizzata, come i divani, dai piedini in metallo e dalla seduta profonda che invita al relax. La poltrona è ancora più classica nella versione con bracciolo basso e fondo piega con bordo in seta.

Of the homonymous series designed by Jean-Marie Massaud, the Bellport armchair is characterized, like the sofas, by the metal feet and the deep seat that invites you to relax. The armchair is even more classic in the version with low armrest and slipcover with silk edge.



Nella pagina precedente: poltrona Bellport rivestimento sfoderabile con fondopiega in tessuto Kitami 09 senape e bordura in seta colore nero, piedini in brown nickel opaco. Tavolino Soori in metallo finitura bronzo anticato. Sistema a giorno Wall System in rovere spessart, schienali laccato lucido canapa e luce led integrata. Tappeto Frame grey. In questa pagina: poltrona Bellport rivestimento sfoderabile in pelle Soft 10 prugna e piedini con profilo in champagne opaco.

Previous page: Bellport armchair with removable slipcover in fabric Kitami 09 senape and border in silk colour nero, mat brown nickel feet. Soori coffee table in metal with antique bronze finish. Wall System in spessart oak, canapa glossy lacquered backs and integrated led light. Carpet Frame grey. This page: Bellport armchair with removable cover in leather Soft 10 prugna and feet with profile in mat champagne.





In questa pagina: poltrona Bellport rivestimento con fondopiega sfoderabile in tessuto Naxos 08 antracite e bordura in seta colore nero, piedini in brown nickel opaco. Nella pagina successiva: poltrona Bellport rivestimento sfoderabile con fondopiega in tessuto Kitami 09 senape e bordura in seta colore nero, piedini in brown nickel opaco.

This page: Bellport armchair with removable slipcover in fabric Naxos 08 antracite and silk border in black colour, mat brown nickel feet. Next page: Bellport armchair with removable slipcover in fabric Kitami 09 senape and border in silk colour nero, mat brown nickel feet.





BELLPORT

Design Jean-Marie Massaud, 2018

Struttura in legno e derivati. Imbottitura seduta e schienale in poliuretano espanso a quote differenziate. Prerivestimento in tela cotone e piuma. Piedini o piedini con profilo in metallo verniciato brown nickel opaco o champagne opaco. Rivestimento tesato sfoderabile in tessuto o pelle. Rivestimento con fondopiega sfoderabile in tessuto con bordura in seta colori da campionario.

Structure in wood and wood by-products. Seat and backrest in multi-density polyurethane foam. Pre-cover in cotton cloth and feather. Feet or feet with profile in mat brown nickel painted metal or mat champagne. Stretched cover in removable fabric or leather. Slipcover in removable fabric with silk border in the colours as per sample book.

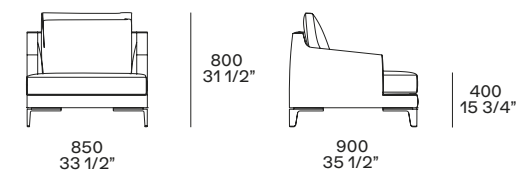

MARLON

La forte personalità di Marlon deriva dall'accostamento fra il basamento in legno e la scocca della seduta plastica ed ergonomica, disponibile con schienali di due altezze diverse. Un progetto di Vincent Van Duysen che parla un linguaggio moderno e sofisticato, con rivestimento in pelle o in tessuto.

The strong personality of Marlon comes from the combination of the wooden base with the plastic and ergonomic body of the seat, available with backs of two different heights. A project by Vincent Van Duysen that speaks a modern and sophisticated language, in leather or fabric.





Nella pagina introduttiva: poltrona Marlon rivestimento sfoderabile in tessuto Sparta 16 ferro, gambe in olmo nero. Nella pagina precedente: poltrone Marlon rivestimento sfoderabile in pelle Soft 14 oliva, gambe in olmo nero. Tavolino Mondrian piano in marmo opaco calacatta oro e struttura in fusione di bronzo lucidata oro. In questa pagina: poltrona Marlon rivestimento sfoderabile in tessuto Nayoro 02 sabbia, gambe in rovere spessart.

Introduction page: Marlon armchair with removable cover in fabric Sparta 16 ferro, legs in black elm. Previous page: Marlon armchairs with removable cover in leather Soft 14 oliva, legs in black elm. Mondrian coffee table with top in mat marble calacatta oro and structure in gold polished bronze casting. This page: Marlon armchair with removable cover in fabric Nayoro 02 sabbia, legs in spessart oak.





In questa pagina: poltrona Marlon rivestimento sfoderabile in velluto Persia 1404 carbone, gambe in olmo nero. Nella pagina successiva: poltrone Marlon rivestimento sfoderabile in tessuto Sparta 16 ferro, gambe in olmo nero. Tavolino Mondrian piano in marmo opaco calacatta oro e struttura in fusione di bronzo lucidata oro.

This page: Marlon armchair with removable cover in velvet Persia 1404 carbone, legs in black elm. Next page: Marlon armchairs with removable cover in fabric Sparta 16 ferro, legs in black elm. Mondrian coffee table with top in mat marble calacatta oro and structure in gold polished bronze casting.





MARLON

Design Vincent Van Duysen, 2016

Scocca e seduta in poliuretano flessibile stampato con parti in poliuretano flessibile a quote differenziate, prerivestimento in fibra di poliestere. Rivestimento sfoderabile in tessuto o pelle. Gambe in massello, finitura in rovere spessart o olmo nero.

Body and shell in flexible moulded polyurethane with parts in multi-density flexible polyurethane, pre-cover in polyester fibre. Removable cover in fabric or leather. Legs in solid wood finish spessart oak or black elm.

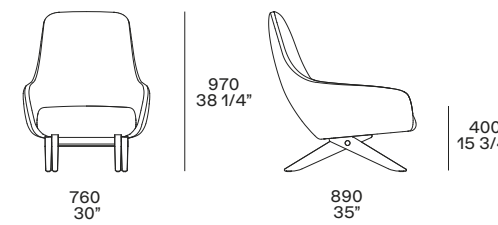
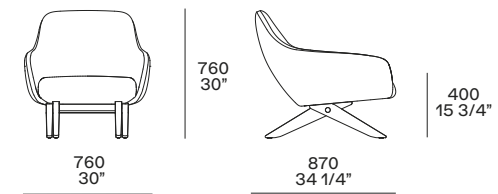



IPANEMA

Con Ipanema Jean-Marie Massaud disegna per Poliform una poltrona raffinata che interpreta un comfort da vivere in libertà. Il design della struttura, controllato e minimale, si combina con l'attenzione per la comodità, con cuscini in appoggio o struttura rivestita in tessuto o pelle. Una poltrona ergonomica e versatile, disponibile anche nella versione sedia.

With Ipanema, Jean-Marie Massaud designs a refined armchair for Poliform that interprets a comfort to be experienced in freedom. The design of the structure, controlled and minimalistic, combines with the attention to comfort, with removable cushions or structure covered in fabric or leather. An ergonomic and versatile armchair, also available in the chair version.





Nella pagina precedente: poltrone Ipanema in olmo nero e seduta con rivestimento non sfoderabile in pelle Nabuk 01 latte. Tavolino Home Hotel in olmo nero. In questa pagina: poltrone Ipanema in rovere spessart, seduta con cinghie in cuoio 03 grigio scuro e cuscino seduta opzionale con rivestimento sfoderabile in velluto Persia 1401 oliva. Libreria pensile Slego in rovere spessart.

Previous page: Ipanema armchairs in black elm and seat with non-removable cover in leather Nabuk 01 latte. Home Hotel coffee table in black elm. This page: Ipanema armchairs in spessart oak, seat with belts in hide 03 grigio scuro and optional seat cushion with removable cover in velvet Persia 1401 oliva. Hanging bookcase Slego in spessart oak.



In questa pagina: poltrona Ipanema in olmo nero e seduta con rivestimento non sfoderabile in pelle Soft 02 mastice.

This page: Ipanema armchair in black elm and seat with non-removable leather Soft 02 mastice.





In questa pagina: poltrona Ipanema in rovere spessart, seduta con cinghie in cuoio 15 prugna e cuscino seduta opzionale con rivestimento sfoderabile in tessuto Zante 18 rubino. Nella pagina successiva: dettaglio poltrona Ipanema in olmo nero e seduta con rivestimento non sfoderabile in pelle Nabuk 01 latte.

This page: Ipanema armchair in spessart oak, seat with belts in hide 15 prugna and optional seat cushion with removable cover in fabric Zante 18 rubino. Next page: close up of Ipanema armchair in black elm and seat with non-removable cover in leather Nabuk 01 latte.

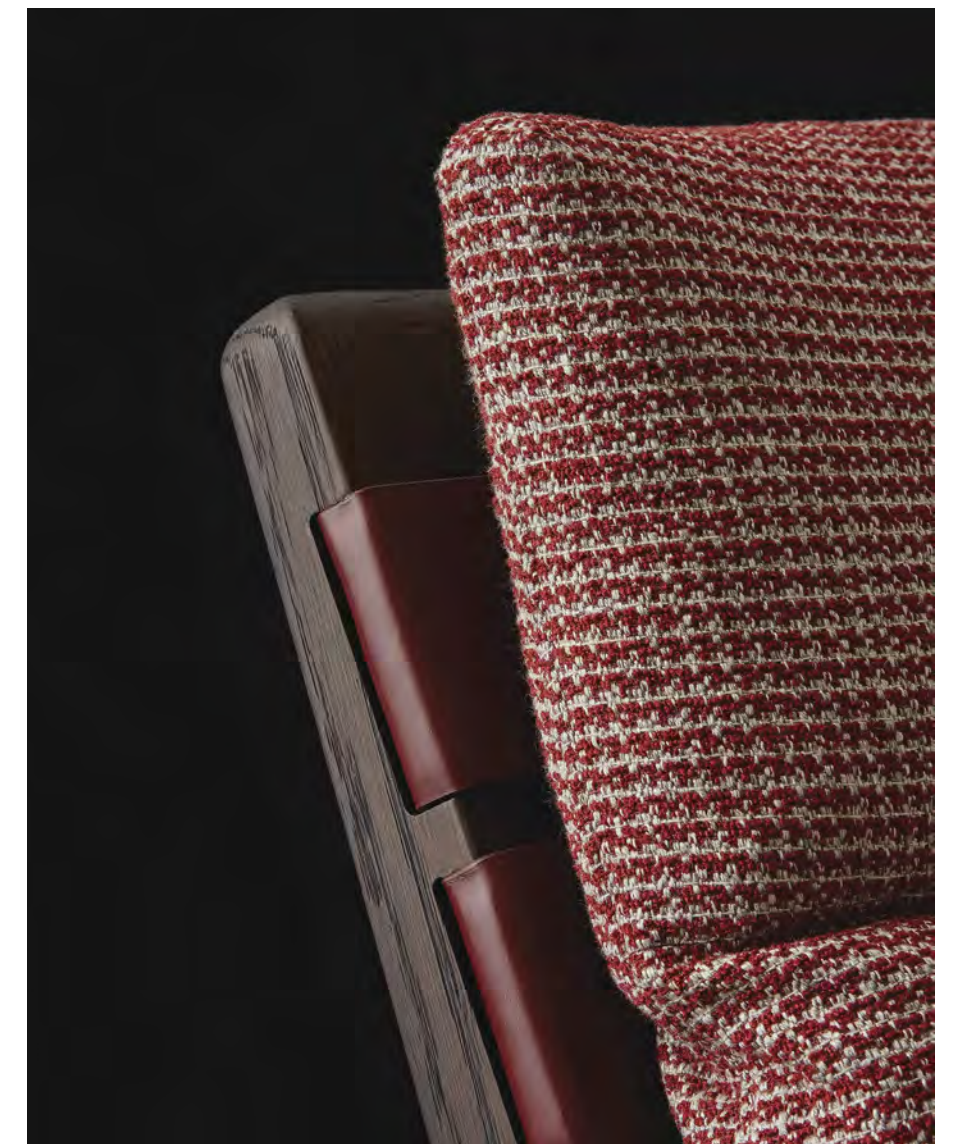



IPANEMA

Design Jean-Marie Massaud, 2013

Struttura in massello, finitura in rovere spessart o olmo nero.
 Seduta con cinghie in cuoio o imbottita.
 Versione con cinghie in cuoio colori, cuscino seduta opzionale con imbottitura in piuma, prriverstimento in tela cotone e rivestimento sfoderabile in tessuto o pelle.
 Versione imbottita in poliuretano flessibile stampato, prriverstimento in fibra di poliestere e rivestimento non sfoderabile in tessuto o pelle.

Structure in solid wood finish spessart oak or black elm.
 Seat with hide belts or upholstered.
 Version with hide belts in the colours as per sample book with optional seat cushion.
 Feather padding, pre-cover in cotton cloth and removable cover in fabric or leather.
 Version with padded seat in flexible moulded polyurethane, pre-cover in polyester fibre and non-removable cover in fabric or leather.

Seduta con cinghie in cuoio Seat with hide belts

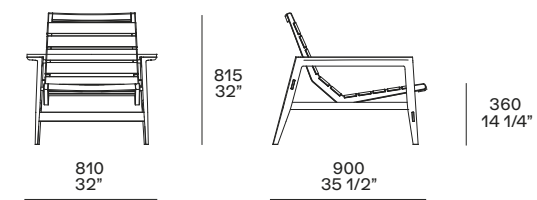

Seduta imbottita Seat upholstered

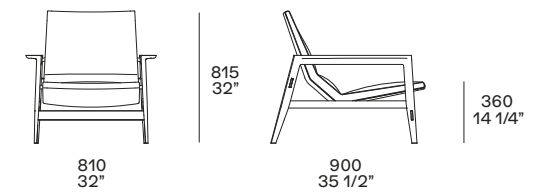

VENTURA LOUNGE

Evoluzione della sedia Ventura, di cui riprende la giunzione fra il basamento e lo schienale della seduta, Ventura Lounge è una poltrona dal grande comfort e massima raffinatezza. Per favorire il rilassamento, lo schienale è allungato e inclinato in modo ergonomico. In alcune versioni in tessuto è possibile far diventare protagoniste le cuciture, con profili a cordoncino in contrasto colore.

Evolution of the Ventura chair, from which it takes the connection between the base and the back of the seat, Ventura Lounge is an armchair of great comfort and maximum refinement. To promote relaxation, the backrest is elongated and inclined ergonomically. In some fabric versions you can put the spotlight on the seams, with corded profiles in contrasting colour.

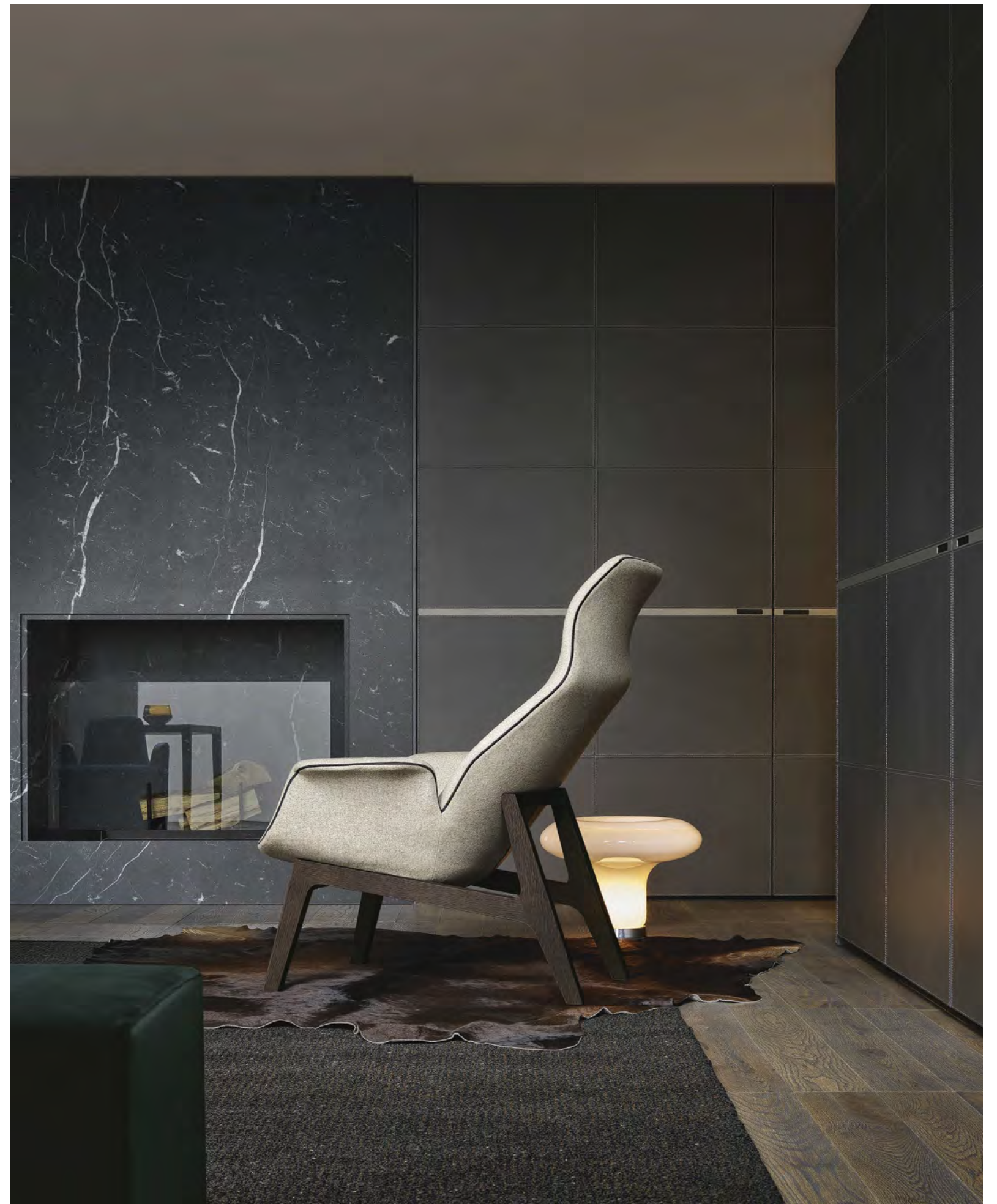

Qui e nella pagina precedente: poltrona Ventura Lounge rivestimento sfoderabile in tessuto Norway 08 avorio e cuciture a cordoncino nero, struttura in rovere spessart. Armadi Senzafine Bangkok, apertura complanare, ante rivestite in cuoio 03 grigio scuro e profilo centrale laccato opaco piombo con maniglia integrata, interni in nobilitato rovere cenere. Sedia Guest rivestimento non sfoderabile in velluto Persia 2012 visone.

This and previous page: Ventura Lounge armchair with removable cover in fabric Norway 08 avorio and drawstring stitching nero, structure in spessart oak. Wardrobes Senzafine Bangkok, coplanar doors covered in hide 03 grigio scuro and piombo mat lacquered central profile with integrated handle, interiors in melamine cenere oak. Guest chair with non-removable cover in velvet Persia 2012 visone.



In questa pagina: poltrona Ventura Lounge rivestimento sfoderabile in tessuto Paros 20 oliva e cuciture a cordoncino acciaio, struttura in rovere spessart.

This page: Ventura Lounge armchair with removable cover in fabric Paros 20 oliva and drawstring stitching acciaio, structure in spessart oak.





In questa pagina: poltrona Ventura Lounge rivestimento sfoderabile in pelle Nabuk 02 tortora e cucitura normale doppia, struttura in olmo nero. Nella pagina successiva: poltrona Ventura Lounge rivestimento sfoderabile in tessuto Siviglia 06 cina e cucitura a cordoncino nero, struttura in rovere spessart. Pouf Elise rivestimento sfoderabile in tessuto Atlanta 26 ghiaccio e cucitura a cordoncino nero. Sistema a giorno Wall System in laccato opaco visone e vetrina integrata Ego Day in vetro fumé.

This page: Ventura Lounge armchair with removable cover in leather Nabuk 02 tortora and normal double stitching, structure in black elm. Next page: Ventura Lounge armchair with removable cover in fabric Siviglia 06 cina and drawstring stitching nero, structure in spessart oak. Elise pouf with removable cover in fabric Atlanta 26 ghiaccio and drawstring stitching nero. Day system Wall System in visone mat lacquer and integrated showcase Ego Day in glass fumé.





VENTURA LOUNGE

Design Jean-Marie Massaud, 2013

Scocca e seduta in poliuretano flessibile stampato, prerivestimento in fibra di poliestere. Rivestimento sfoderabile in tessuto o pelle. Cucitura normale doppia o a cordoncino con filato nei diversi colori da campionario (escluso rivestimento in pelle e velluto). Struttura in massello, finitura in rovere spessart o olmo nero.

Body and seat in flexible moulded polyurethane, pre-cover in polyester fibre. Removable cover in fabric and leather. Normal double stitching or drawstring stitching with yarn in the colours as per sample book (except for cover in leather and in velvet). Structure in solid wood finish spessart oak or black elm.

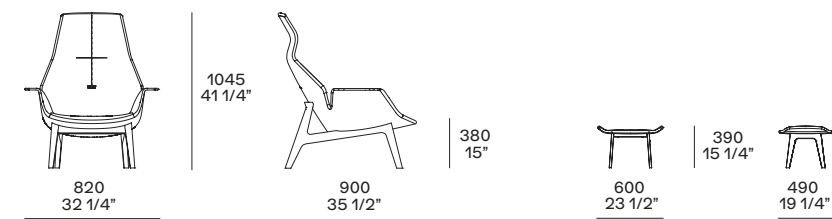



CAMILLA

La classica poltrona con braccioli, riproposta in chiave attuale, diventa una poltrona profonda e accogliente, raffinata nella sua semplicità e impreziosita dalla struttura in essenza e dal rivestimento in tessuto o pelle. Un equilibrio sapiente di design essenziale, rimandi formali e rilassante comodità. Camilla si inserisce con stile in tutti gli ambienti della casa, nella zona giorno e nella zona notte.

The classic armchair with armrests, re-proposed in a modern key, becomes a deep and welcoming armchair, refined in its simplicity and embellished by the wooden structure and the covering in fabric or leather. A wise balance of minimalistic design, formal references, and relaxing comfort. Camilla fits with style in all the environments of the house, in the day area and in the night area.



Nella pagina precedente: poltrona Camilla rivestimento sfoderabile in tessuto Hannover 05 ardesia e struttura in rovere spessart. Pouf Play rivestimento sfoderabile in velluto Persia 23 arena. In questa pagina: poltrona Camilla rivestimento sfoderabile in pelle Special 30 cemento e struttura in rovere spessart, cuscino poggiatesta opzionale.

Previous page: Camilla armchair with removable cover in fabric Hannover 05 ardesia and spessart oak structure. Play pouf with removable cover in velvet Persia 23 arena. This page: Camilla armchair with removable cover in leather Special 30 cemento and spessart oak structure, optional lower back cushion.





In questa pagina: poltrona Camilla rivestimento sfoderabile in tessuto Kitami 02 cenere e struttura in noce c.. Nella pagina successiva: poltrone Camilla rivestimento sfoderabile in tessuto Hannover 05 ardesia e struttura in rovere spessart. Pouf Play rivestimento sfoderabile in velluto Persia 23 arena. Sotto: dettaglio del retro con schienale in paglia intrecciata.

This page: Camilla armchair with removable cover in fabric Kitami 02 cenere and structure in walnut c. Next page: Camilla armchairs with removable cover in fabric Hannover 05 ardesia and spessart oak structure. Play pouf with removable cover in velvet Persia 23 arena. Below: close up of the backside in woven straw.





CAMILLA

Design R&D Poliform, 2006

Seduta e schienale in poliuretano espanso a quote differenziate e piuma. Prerivestimento in tela di cotone. Rivestimento sfoderabile in tessuto o pelle. Struttura in massello, finitura in rovere spessart o noce c. Cuscino salvareni opzionale, rivestimento sfoderabile in tessuto o pelle.

Seat and backrest in multi-density polyurethane foam and feather. Pre-cover in cotton cloth. Removable cover in fabric and leather. Structure in solid wood finish spessart oak or walnut c. Optional lower back cushion, removable cover in fabric and leather.

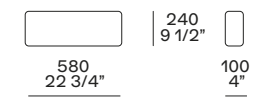
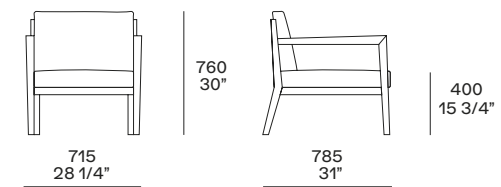

cuscino salvareni
kidneyrest cushion

SOORI HIGHLINE

Soo Chan disegna una poltrona confortevole dall'eleganza discreta. La struttura in essenza, semplice e squadrata, sostiene una seduta dalla cospicua profondità e morbidezza, accresciuta dai braccioli imbottiti. Dettagli raffinati i bordi dei cuscini, sottolineati da gros-grain in tinta o con colore a contrasto.

Soo Chan designs a comfortable armchair of discreet elegance. The wooden structure, simple and squared, supports a seat with considerable depth and softness, enhanced by the padded armrests. The edges of the cushions are refined details, highlighted by grosgrain in the same colour or a contrasting one.



Nella pagina precedente: poltrone Soori Highline rivestimento non sfoderabile in velluto Persia 2006 prugna e bordure gros-grain nero, struttura in rovere spessart. Madia Bristol in rovere spessart, inserti e piedini in brown nickel opaco, contenitore laccato opaco carbone. In questa pagina: poltrona Soori Highline rivestimento non sfoderabile in pelle Nabuk 06 mastice e bordure gros-grain nero, struttura in rovere spessart. Sotto: dettaglio della bordura gros-grain del cuscino schienale e del controschienale imbottito e rivestito.

Previous page: Soori Highline armchairs with non-removable cover in velvet Persia 2006 prugna and border in grosgrain nero, spessart oak structure. Bristol System sideboard in spessart oak, inlays and feet in mat brown nickel, carbone mat lacquered storage units. This page: Soori Highline armchair with non-removable cover in leather Nabuk 06 mastice and border in grosgrain nero, spessart oak structure. Below: close up of the grosgrain border of the backrest cushion and of the upholstered and covered backrest.

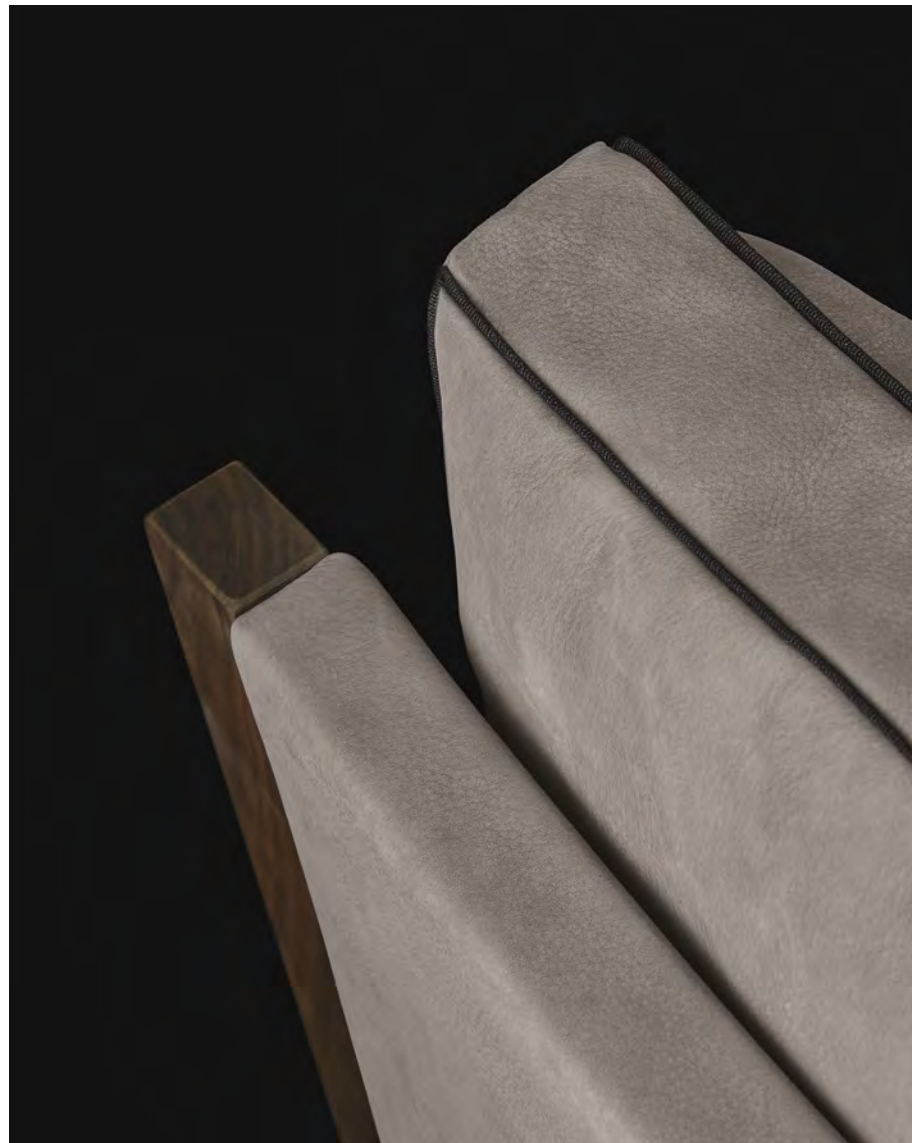



In questa pagina: poltrona Soori Highline rivestimento non sfoderabile in tessuto Sparta 36 rubino e bordure gros-grain nero, struttura in rovere spessart. Nella pagina successiva: poltrona Soori Highline rivestimento non sfoderabile in velluto Persia 2006 prugna e bordure gros-grain nero, struttura in rovere spessart. Sistema a giorno Wall System con struttura, schienali e inserti attrezzati rovere spessart, ante Slim apertura a ribalta laccato opaco visone. Divano Paris Seoul rivestimento sfoderabile in tessuto Merida 99 écru.

This page: Soori Highline armchair with non-removable cover in fabric Sparta 36 rubino and border in grosgrain nero, spessart oak structure. Next page: Soori Highline armchair with non-removable cover in velvet Persia 2006 prugna and border in grosgrain nero, spessart oak structure. Day system Wall System with structure, backs and accessorized inserts in spessart oak, visone mat lacquered Slim flap doors. Paris Seoul sofa removable cover in fabric Merida 99 écru.





SOORI HIGHLINE

Design Soo Chan, 2014

Seduta e schienale in poliuretano espanso a quote differenziate e piuma. Prerivestimento in tela di cotone. Rivestimento non sfoderabile in tessuto o pelle. Cucitura normale doppia o bordura gros-grain nei diversi colori da campionario. Struttura in massello, finitura in rovere spessart. Braccioli e contro schienale in poliuretano rigido rivestiti in tessuto o pelle non sfoderabili.

Seat and back in multi-density polyurethane foam and feather. Pre-cover in cotton cloth. Non-removable cover in fabric or leather. Normal double stitching or grosgrain border in the colours as per sample book. Structure in solid wood finish spessart oak. Armrests and backrest in rigid polyurethane covered in non-removable fabric and leather.

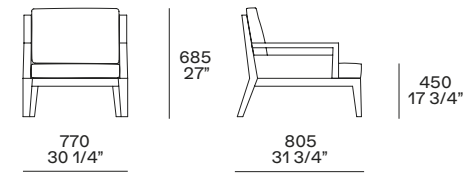



GASTON

Lineare, essenziale, invitante. La poltroncina Gaston, disegnata da Vincent Van Duysen, evoca uno stile esclusivo e lo conferma nei dettagli come gli spessori minimali della struttura in metallo, le cuciture e il rivestimento del bracciolo, sottile e confortevole. Disponibile con rivestimento in pelle o tessuto, Gaston arreda con raffinatezza gli ambienti giorno e notte.

Linear, minimalistic, inviting. The Gaston armchair, designed by Vincent Van Duysen, evokes an exclusive style and confirms it in the details like the minimal thicknesses of the metal structure, the stitching, and the covering of the armrest, thin and comfortable. Available in leather or fabric, Gaston furnishes the day and night environments with refinement.



Nella pagina precedente: poltrona Gaston rivestimento non sfoderabile in pelle Soft 13 carbone, struttura verniciata lucido carbone. Tappeto Soft. In questa pagina: poltrona Gaston rivestimento non sfoderabile in pelle Nabuk 07 camoscio, struttura verniciata lucido bianco. Sotto: dettaglio del bracciolo che nella variante seduta in pelle viene rivestito con la stessa pelle.

Previous page: Gaston armchair with non-removable cover in leather Soft 13 carbone, carbone glossy lacquered structure. Carpet Soft. This page: Gaston armchair with non-removable cover in leather Nabuk 07 camoscio, bianco glossy lacquered structure. Below: close up of the armrest that, in the version with leather covered seat cushion, is covered with the same material.





In questa pagina: poltrona Gaston rivestimento sfoderabile in tessuto Kitami 11 oceano, struttura verniciata brown nickel opaco. Sotto: dettaglio del bracciolo che nella variante seduta in tessuto viene rivestito con una pelle in tinta alla struttura. Nella pagina successiva: poltrone Gaston rivestimento non sfoderabile in pelle Soft 13 carbone, struttura verniciata lucido carbone. Boiserie e letto Dream rivestimento sfoderabile in velluto Persia 1404 carbone e pelle Special 40 ardesia. Comodini Dream in laccato lucido moka. Tappeto Soft.

This page: Gaston armchair with removable cover in fabric Kitami 11 oceano, mat brown nickel painted structure. Below: close up of the armrest that, in the version with fabric covered seat cushion, is covered in leather in matching colour with the structure. Next page: Gaston armchairs with non-removable cover in leather Soft 13 carbone, carbone glossy painted structure. Wall panelling and bed Dream with removable cover in velvet Persia 1404 carbone and leather Special 40 ardesia. Moka glossy lacquered Dream night tables. Carpet Soft.

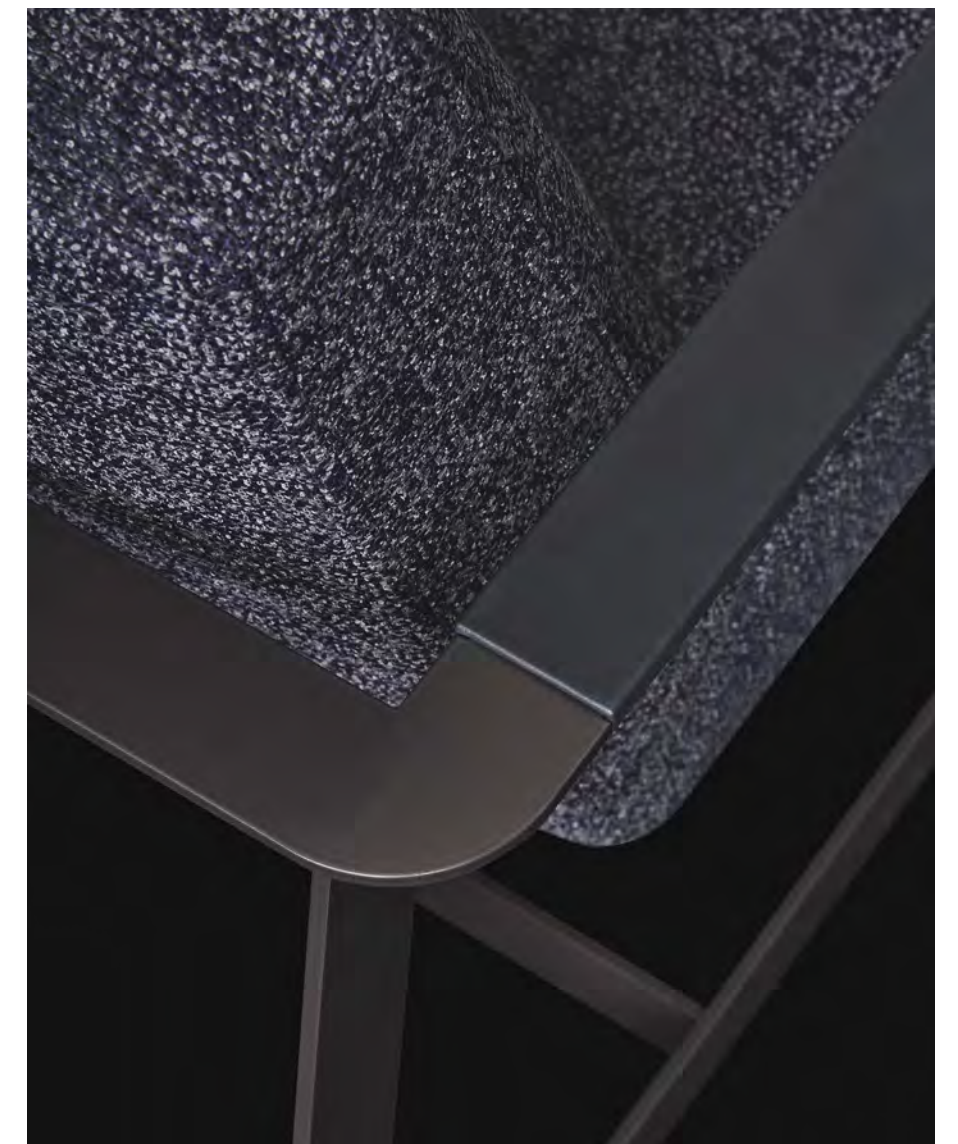



GASTON

Design Vincent Van Duysen, 2008

Scocca in poliuretano stampato con inserti di poliuretano espanso a quote differenziate e piuma, priverivestimento in tela cotone e fibra di poliestere. Rivestimento in tessuto sfoderabile o in pelle non sfoderabile. Struttura in metallo verniciato brown nickel opaco e lucido o lucido bianco e carbone. Braccioli rivestiti in pelle o come il rivestimento della seduta o in tinta alla struttura se il rivestimento della seduta è in tessuto.

Body in moulded polyurethane with inlays in multi-density polyurethane foam and feather, pre-cover in cotton cloth and polyester fibre. Cover in removable fabric or in non-removable leather. Structure in painted metal mat and glossy brown nickel or glossy bianco and carbone. Armrests covered in leather or in the same material of the seat cushion; if the seat cushion is in fabric, the armrests are leather covered in the same colour of the structure.

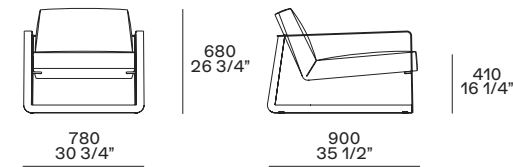

BB

Alla sedia BB fa seguito la poltrona, sempre progettata da Riccardo Blumer e Matteo Borghi. Cambiano le proporzioni, con una seduta più ampia, compatta e accogliente. Rimane l'esoscheletro a vista iniettato con poliuretano espanso: agile e leggero, privo di braccioli, è rivestito in cuoio.

The BB chair is followed by the armchair, still designed by Riccardo Blumer and Matteo Borghi. The proportions change, with a wider seat, compact and welcoming. The exposed exoskeleton injected with polyurethane foam remains: light and agile, without armrests, it is covered in leather.



Nella pagina precedente: poltrona BB completamente rivestita in cuoio non sfoderabile 02 nero. In questa pagina: poltrona BB completamente rivestita in cuoio non sfoderabile 26 invecchiato.

Previous page: BB armchair fully covered in non-removable hide 02 nero. This page: BB armchair fully covered in non-removable hide 26 invecchiato.





In questa pagina: poltrona BB completamente rivestita in cuoio non sfoderabile 02 nero. Nella pagina successiva: poltrona BB completamente rivestita in cuoio non sfoderabile 26 invecchiato. Armadio Senzafine Plus, apertura battente con ante in laccato opaco roccia e maniglie integrate Plus verniciate ardesia. Parte centrale ante Ego in vetro line con telaio e maniglie verniciato ardesia. Pouf New York rivestimento sfoderabile in tessuto Kitami 10 terracotta.

This page: BB armchair fully covered in non-removable hide 02 nero. Next page: BB armchair covered in non-removable hide 26 invecchiato. Wardrobe Senzafine Plus, leaf opening with roccia mat lacquered doors and ardesia painted integrated Plus handles. Central unit with Ego doors in glass line, frame and handles painted ardesia. New York pouf with removable cover in fabric Kitami 10 terracotta.





BB

Design Blumer e Borghi, 2009

Struttura in poliuretano rigido a bassa densità, completamente rivestita e non sfoderabile in cuoio co-stampato nei colori 02 nero, 03 grigio scuro, 19 caffè o 26 invecchiato.

Structure in rigid polyurethane in low density, fully covered in non-removable hide in the colours 02 nero, 03 grigio scuro, 19 caffè or 26 invecchiato.

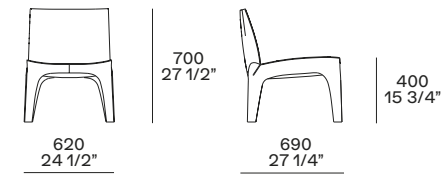

WALLACE

Jean-Marie Massaud firma una proposta dal design fortemente innovativo. Wallace è una poltrona di grande effetto, con un basamento in metallo dalle geometrie irregolari che sorregge la struttura in poliuretano rivestito in pelle. La seduta attira lo sguardo con la sua forma particolare, avvolgendo in un comfort unico chi vi si adagia.

Jean-Marie Massaud signs an item with a highly innovative design. Wallace is an armchair of great impact, with a metal base with irregular geometric shapes that supports the polyurethane structure covered in leather. The seat catches the eye with its particular shape, enveloping in a unique comfort who lies on it.







WALLACE

Design Jean-Marie Massaud, 2010

Scocca in poliuretano flessibile stampato.
Rivestimento non sfoderabile in pelle.
Struttura in metallo verniciato brown nickel
opaco o lucido.

Body in flexible moulded polyurethane.
Cover in non-removable leather.
Structure in mat or glossy brown nickel
painted metal.

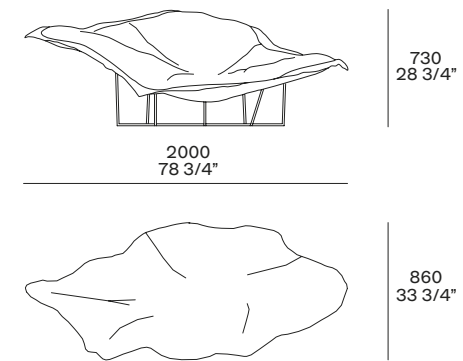

Qui e nelle pagine precedenti: poltrona Wallace rivestimento non sfoderabile in pelle Special 14 nero e struttura in brown nickel opaco.

This and previous pages: Wallace armchair with non-removable cover in leather Special 14 nero and mat brown nickel structure.

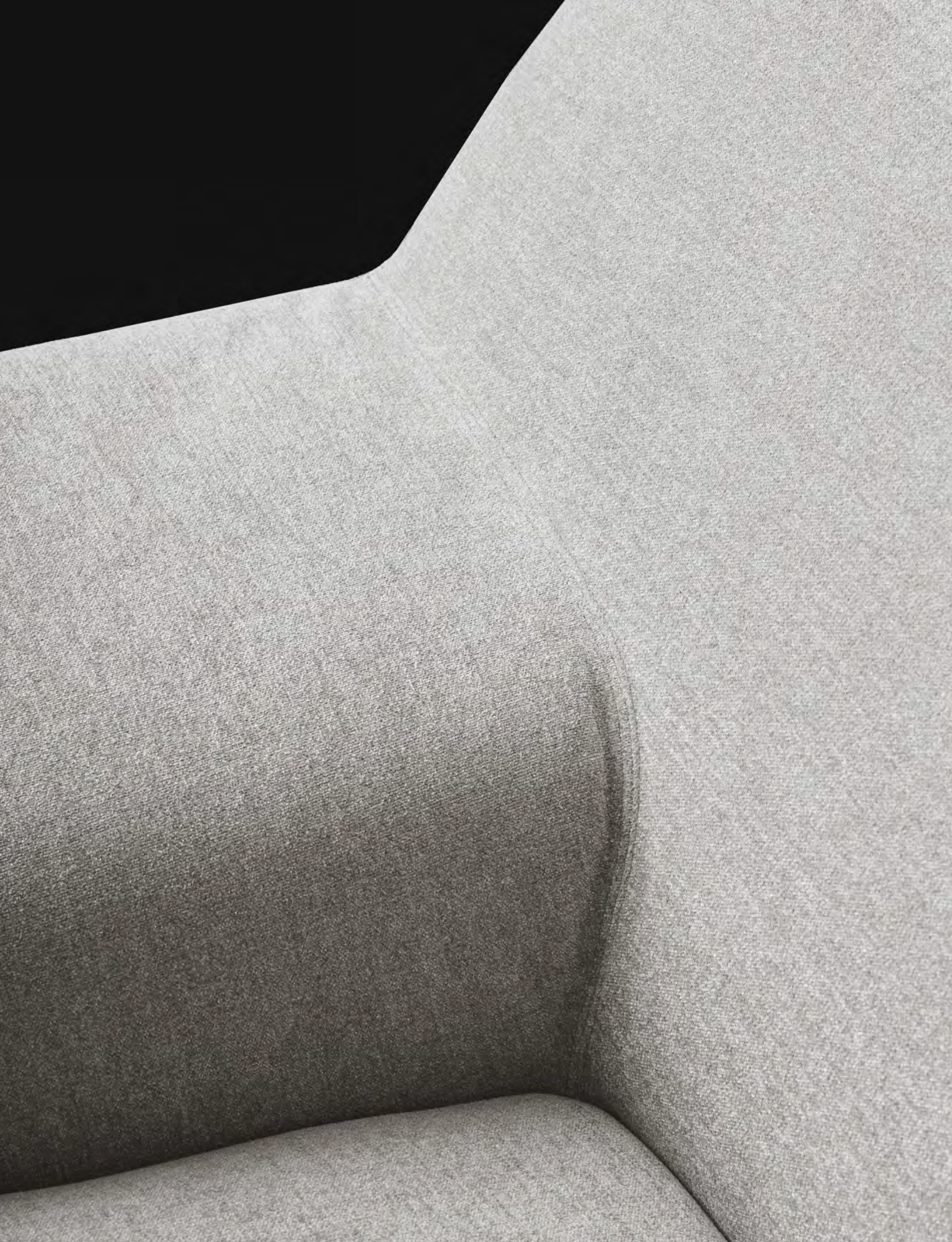

BIG BUG

Paola Navone disegna una poltrona extralarge in cui abbandonarsi, un paradiso di comfort e relax. Con il suo schienale lievemente inclinato, Big Bug è dotata di un unico, morbido e ampio bracciolo, posto a scelta a destra o a sinistra. Il rivestimento propone numerose varianti di tessuti e pelli.

Paola Navone designs an extra-large armchair where you can abandon yourself – a paradise of comfort and relaxation. With its slightly inclined backrest, Big Bug has a single, soft, and wide armrest, placed as desired on the right or on the left. The covering offers numerous variations of fabrics and leathers.







BIG BUG

Design Paola Navone, 2009

Struttura in legno e derivati. Imbottitura seduta e schienale in poliuretano espanso a quote differenziate. Prerivestimento in fibra di poliestere accoppiata. Piedini in materiale plastico o base girevole. Rivestimento in tessuto sfoderabile o pelle non sfoderabile.

Structure in wood and wood-by products. Seat and backrest in multi-density polyurethane foam. Pre-cover in polyester fibre. Feet in plastic material or swivel base. Cover in removable fabric or non-removable leather.

Bracciolo sx-dx Lt-rt arm

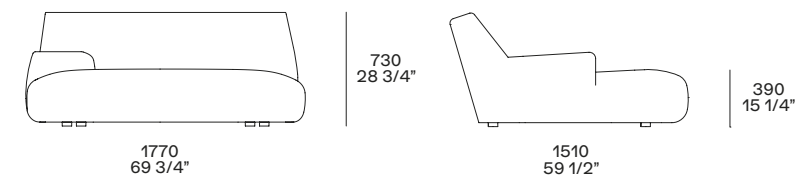

Nella pagina precedente: poltrona Big Bug con bracciolo sinistro, rivestimento sfoderabile in tessuto Naxos 07 cemento. Sopra: poltrona Big Bug con bracciolo destro, rivestimento non sfoderabile in pelle Special 18 bianco.

Previous page: Big Bug armchair with left armrest, removable cover in fabric Naxos 07 cemento. Above: Big Bug armchair with right armrest, non-removable cover in leather Special 18 bianco.

TECHNICAL DATA

TAPPETI
CARPETS

444

FINITURE
FINISHINGS

448

INDICE PRODOTTI
PRODUCT INDEX

454

TAPPETI
CARPETS

Frame

Prodotto a mano con tecnica handloom.
Trama in cotone, vello in seta di bambù.
Bordo perimetrale di 80 mm in lana
himalayana in tinta solo per la versione
rettangolare.
Dimensioni mm: rettangolare 1700x2400
2300x3000 - 3000x4000
quadrato 3000x3000 - ovale 2300x4000.

Handmade with the handloom technique.
Cotton weave, fleece in bamboo silk.
80 mm - 3 1/4" perimeter edge in Himalayan
wool in matching color only for the
rectangular version.
Dimensions inches: rectangular 67"x94 1/2"
90 1/2"x118" - 118"x157 1/2"
square 118"x118" - oval 90 1/2"x157 1/2".



Grey



Gold



Perla



Oceano



Prugna



Carbone



Plain

Prodotto a mano con tecnica handloom.
Trama in cotone, vello in aloe e seta di bambù.
Versione rettangolare bordo di 150 mm in
tonalità più scura sul lato superiore e inferiore
e di 100 mm per la dimensione 1700x2400.
Nella versione tonda la parte più scura è di
1/4 del tappeto.
Dimensioni mm: rettangolare 1700x2400
2300x3000 - 3000x4000
quadrato 3000x3000 - rotondo Ø 2500.

Handmade with the handloom technique.
Cotton weave, fleece in aloe and bamboo silk.
Rectangular version 150 mm - 6" edge in
darker colour in the upper and lower side and
100 mm - 4" edge for the size 1700x2400.
In the round version the darkest part is
1/4 of the carpet.
Dimensions inches: rectangular 67"x94 1/2"
90 1/2"x118" - 118"x157 1/2"
square 118"x118" - round Ø 94 1/2".



Tortora

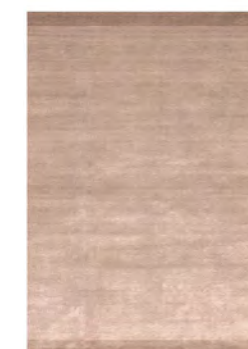

Cipria

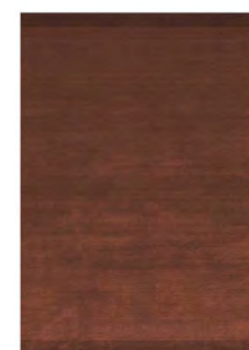
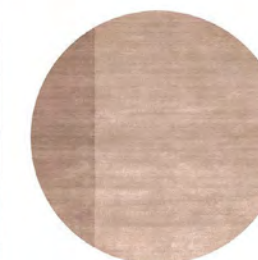

Ruggine

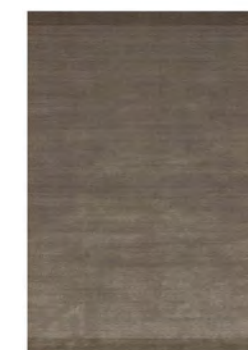

Arena



Natural



TAPPETI CARPETS

Dama

Prodotto a mano con tecnica handloom.
Trama in cotone, vello in lana himalayana e seta di bambù.
Dimensioni mm: rettangolare 1100×3500
1700×2400 - 2300×3000 - 3000×4000
quadrato 3000×3000.

Handmade with the handloom technique.
Cotton weave, fleece in Hymalayan wool and bamboo silk.
Dimensions inches: rectangular 43 1/4"x137 1/4" - 67"x94 1/2" - 90 1/2"x118" - 118"x157 1/2" square 118"x118".



Soft

Prodotto a mano con tecnica handloom.
Trama in cotone, vello in seta di bambù grigio sfumato.
Dimensioni mm: rettangolare 1700×2400
2300×3000 - 3000×4000
quadrato 3000×3000.

Handmade with the handloom technique.
Cotton weave, fleece in bamboo silk shaded grey.
Dimensions inches: rectangular 67"x94 1/2" - 90 1/2"x118" - 118"x157 1/2" square 118"x118".



Stripes

Prodotto a mano con tecnica handloom.
Trama in cotone, vello in lana himalayana e seta di bambù.
Dimensioni mm: rettangolare 1100×3500
1700×2400 - 2300×3000 - 3000×4000
quadrato 3000×3000.

Handmade with the handloom technique.
Cotton weave, fleece in Hymalayan wool and bamboo silk.
Dimensions inches: rectangular 43 1/4"x137 1/4" - 67"x94 1/2" - 90 1/2"x118" - 118"x157 1/2" square 118"x118".



FINITURE
FINISHINGS

Laccato opaco e lucido
Mat and glossy lacquered

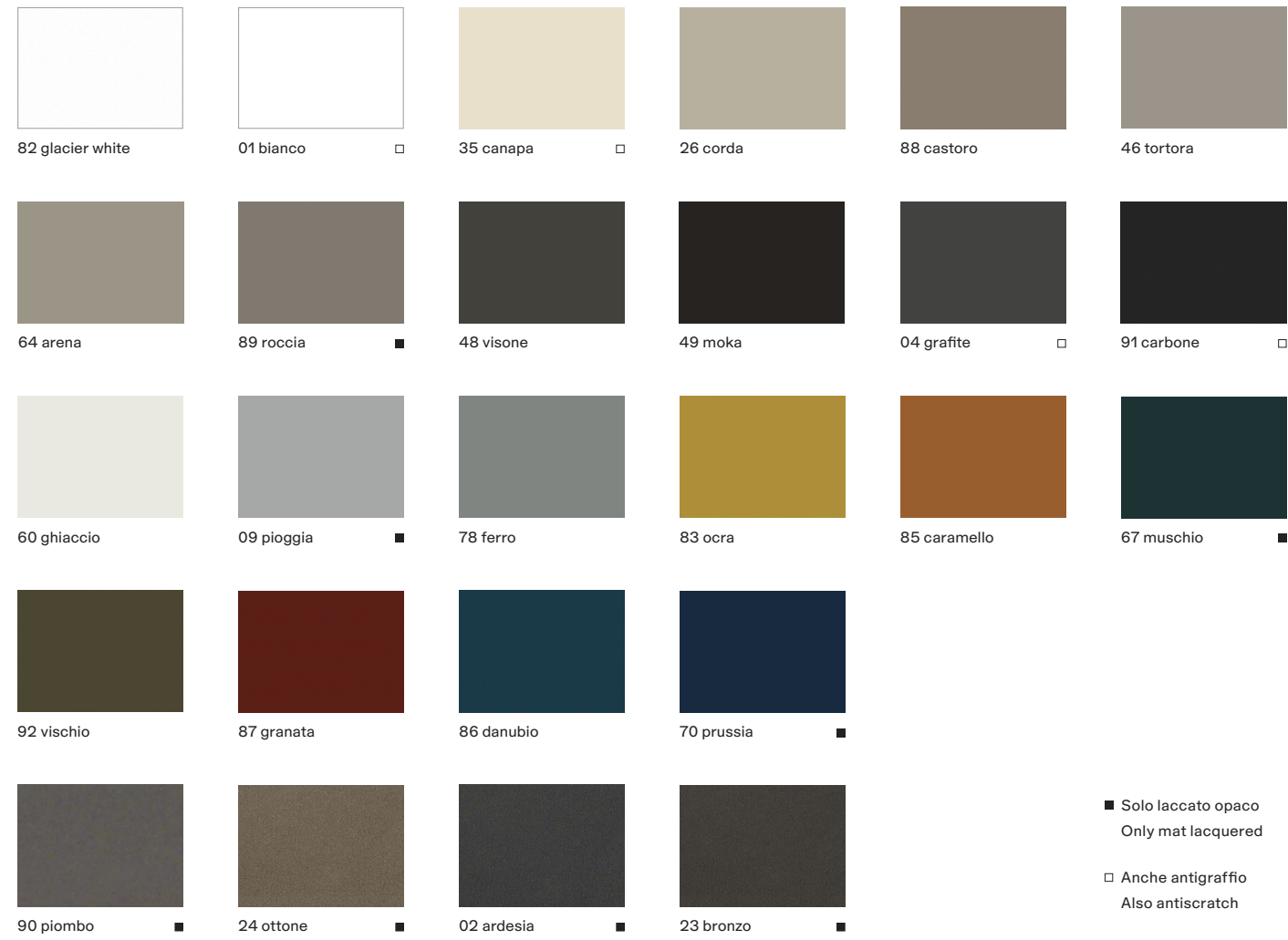

■ Solo laccato opaco
Only mat lacquered

□ Anche antigraffio
Also antiscratch

Laccato metallico
Metallic lacquered



Tecnopelle
Techno leather



Essenza
Wood

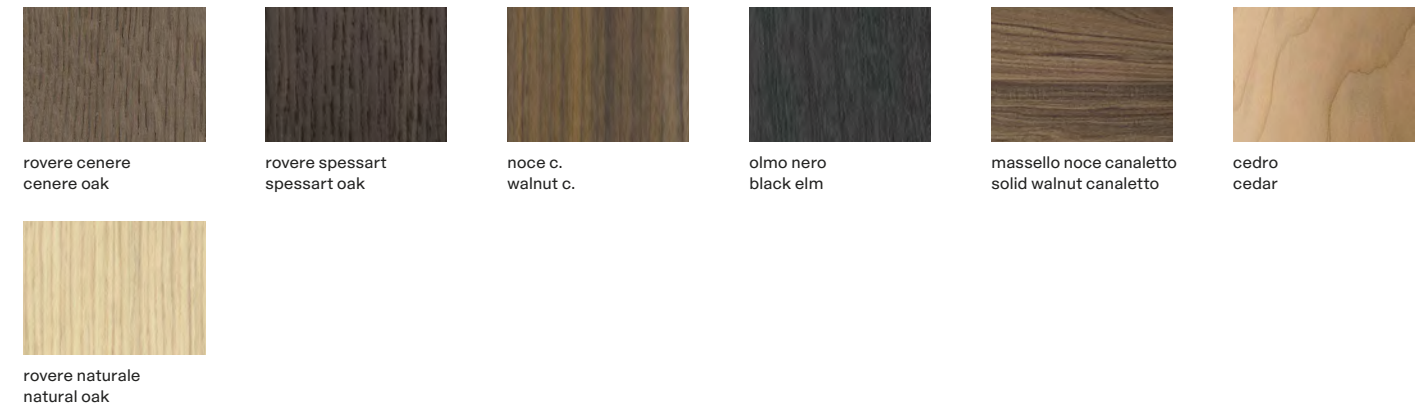

Nobilitato
Melamine

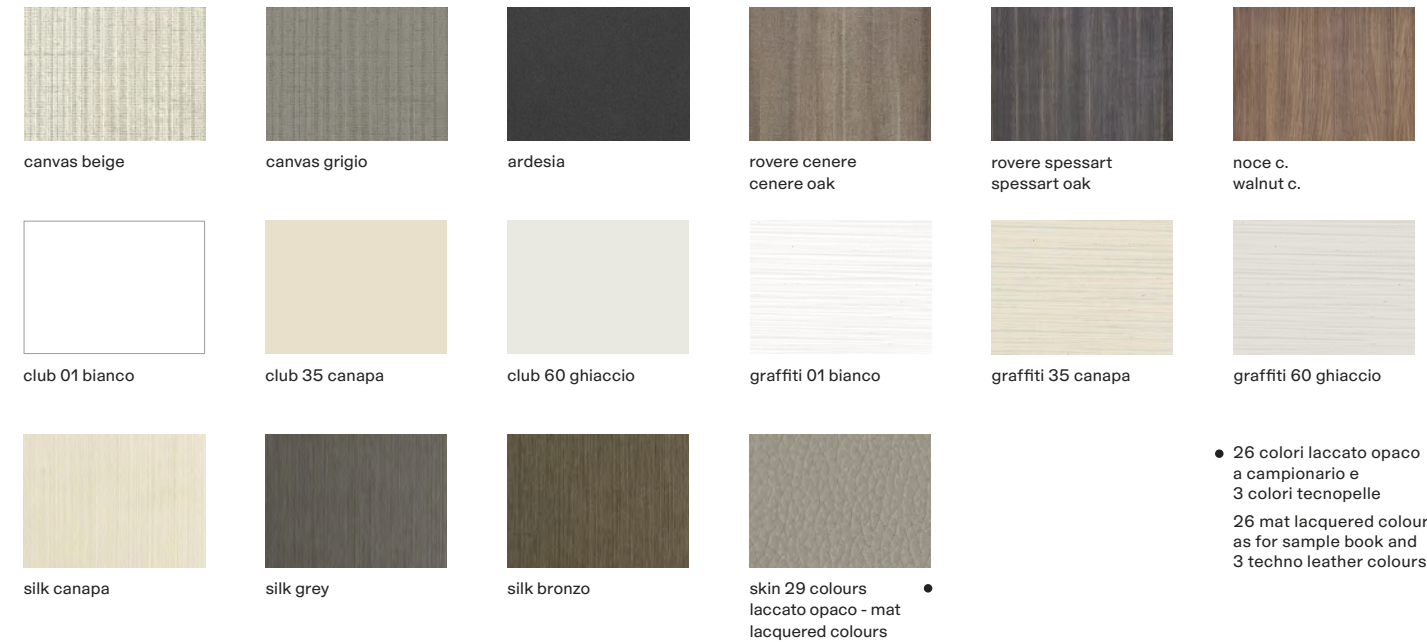

● 26 colori laccato opaco
a campionario e
3 colori tecnopelle
26 mat lacquered colours
as for sample book and
3 techno leather colours

Metacrilato
Methacrylate

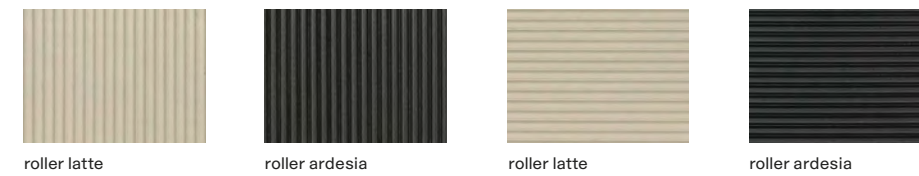

Nobilitato interno cassetti
Melamine drawers structure



FINITURE
FINISHINGS

**Vetro
Glass**



1000 trasparente
transparent



2000 trasparente
extrachiaro-transparent
extralight



3050 fumé

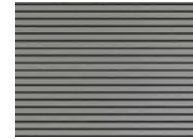

2700 line

**Vetro riflettente
Reflecting glass**

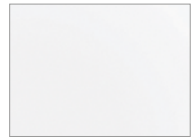

5000 trasparente
transparent

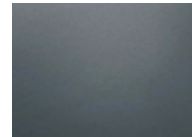

5010 blu



5051 bronzato
bronzed

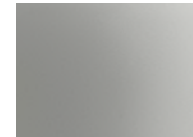

5059 fumé

**Vetro acidato
Etched glass**

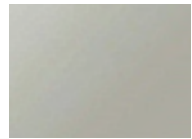

5380 acciaio

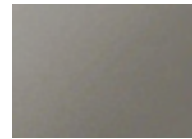

5323 bronzo

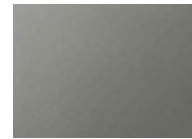

5325 titanio

**Specchio
Mirror**

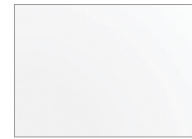

4000 bianco
white



4051 bronzato
bronzed

**Vetro satinato
Mat glass**

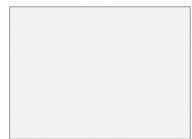

2301 bianco

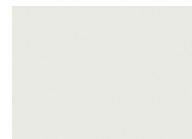

2373 ghiaccio

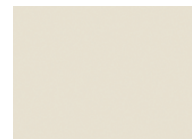

1335 canapa



1364 arena



1304 grafite



1303 nero

**Vetro lucido
Glossy glass**

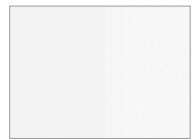

2201 bianco



2273 ghiaccio



1235 canapa



1264 arena



1204 grafite

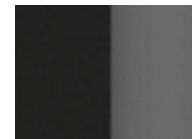

1203 nero

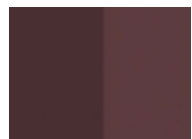

1259 bordeaux

**Marmo levigato
Mat marble**



bianco carrara



calacatta oro

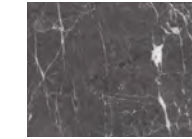

grigio stardust

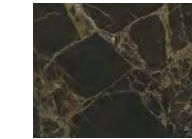

emperador dark

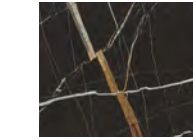

sahara noir
finitura poliestere
polyester finish

**Marmo lucido
Glossy marble**



bianco carrara



calacatta oro

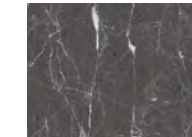

grigio stardust

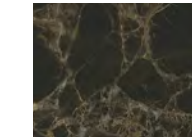

emperador dark

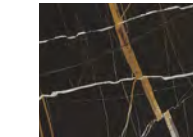

sahara noir
finitura poliestere
polyester finish

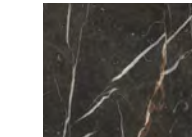

noir saint laurent

**Marmo e onice
Marble and onyx**



nero assoluto
texture juta



lapislazzulo blu
blue lapis lazuli



onice ambra
onyx amber

**Parti metalliche
Metal parts**

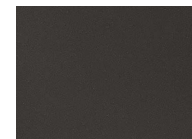

brown nickel opaco
mat brown nickel

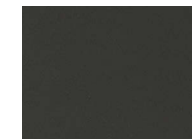

brown nickel lucido
glossy brown nickel

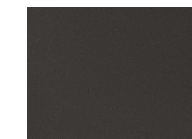

brown nickel satinato
brushed brown nickel



champagne opaco
mat champagne



champagne satinato
brushed champagne



cromo nero
black chrome



piombo
opaco - mat



ardesia
opaco - mat



bronzato
bronzed



bronzato
antique bronze



oro lucido
glossy gold



alluminio brill
aluminium brill

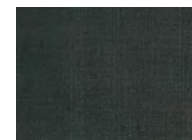

spatolato ferro
spatula-finish ferro

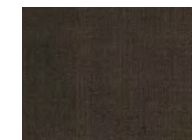

spatolato bronzo
spatula-finish bronzo

FINITURE
FINISHINGS

Tessuti
Fabrics

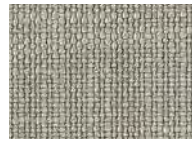

atlanta cat. b
12 colori - colours



chios cat. b
13 colori - colours

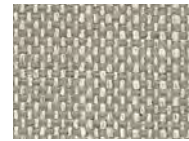

aspen cat. c
12 colori - colours

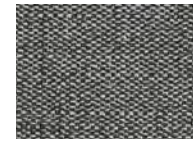

lima cat. c
11 colori - colours



saviglia cat. c
14 colori - colours



caledonia cat. d
9 colori - colours



cordoba cat. d
13 colori - colours



corinto cat. d
5 colori - colours



indra cat. d
12 colori - colours



itaca cat. d
10 colori - colours



kushiro cat. d
13 colori - colours



lipsi cat. d
11 colori - colours



milos cat. d
5 colori - colours



olimpia cat. d
14 colori - colours

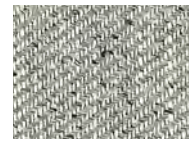

oxford cat. d
8 colori - colours



rabat cat. d
10 colori - colours



sendai cat. d
5 colori - colours



sparta cat. d
12 colori - colours



argo cat. e
13 colori - colours

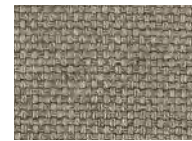

hannover cat. e
11 colori - colours

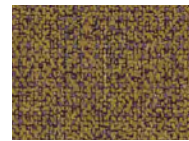

kitami cat. e
12 colori - colours



merida cat. e
8 colori - colours

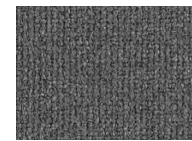

naxos cat. e
11 colori - colours



nayoro cat. e
10 colori - colours



norway cat. e
13 colori - colours

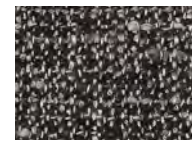

orleans cat. e
10 colori - colours



paros cat. e
11 colori - colours



persia cat. e
16 colori - colours



salford cat. e
11 colori - colours



skyros cat. e
12 colori - colours

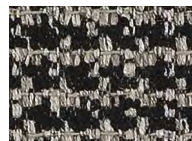

zante cat. e
11 colori - colours

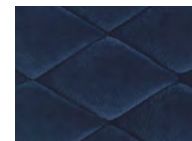

gibson cat. z
8 colori - colours

Cuoio
Hide



28 avorio

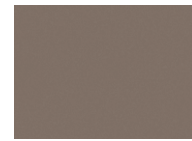

29 tortora



19 caffè



38 oliva

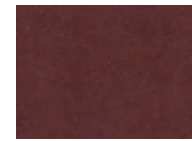

15 prugna



26 invecchiato



03 grigio scuro



02 nero

Pelle
Leather

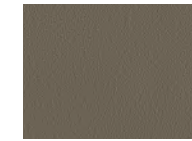

spring cat. p
13 colori - colours



colors cat. s
25 colori - colours



vintage cat. s
5 colori - colours



special cat. x
21 colori - colours

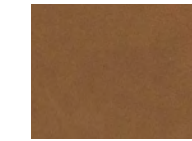

nabuk cat. y
10 colori - colours

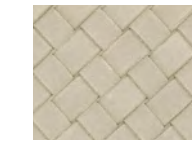

nabuk intrecciata cat. y
woven leather nabuk
10 colori - colours



invecchiata cat. y
6 colori - colours



soft cat. y
14 colori - colours

Pelle Cashmere
Cashmere leather



bianco



grigio



nero

Bordura gros-grain - bordura in seta - filati
Grosgrain border - silk border - yarns



burro



perla



sahara

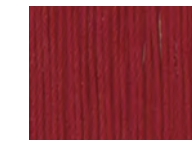

rubino

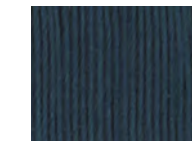

tempesta



navy



acciaio

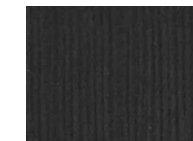

nero

● escluso bordura in seta
except silk border

Provence coordinati letto
Bed linen Provence



001 bianco

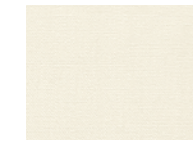

002 panna



008 polvere



004 tortora



006 roccia



007 grafite



003 ghiaccio

DIVANI
SOFAS



Bellport, design Jean-Marie Massaud
pp. 10-47



Mondrian, design Jean-Marie Massaud
pp. 48-83



Bristol, design Jean-Marie Massaud
pp. 84-119



Dune, design Carlo Colombo
pp. 120-141



Sydney, design Jean-Marie Massaud
pp. 142-157



Tribeca, design Jean-Marie Massaud
pp. 158-173



Shangai, design Carlo Colombo
pp. 174-187



Paris Seoul, design Jean-Marie Massaud
pp. 188-201



Airport, design Paola Navone
pp. 202-213

POLTRONE
ARMCHAIRS



Jane, design Emmanuel Gallina
pp. 218-231



Jane Large, design Emmanuel Gallina
pp. 232-239



Jane Lounge, design Emmanuel Gallina
pp. 240-247



Mad Chair, design Marcel Wanders
pp. 248-265



Mad Joker, design Marcel Wanders
pp. 266-273



Mad Queen, design Marcel Wanders
pp. 274-281



Mad Chaise Longue, design Marcel Wanders
pp. 282-285



Mad King, design Marcel Wanders
pp. 286-293

POLTRONE
ARMCHAIRS



Stanford, design Jean-Marie Massaud
pp. 294-305



Stanford Lounge, design J.M. Massaud
pp. 306-313



Santa Monica, design Jean-Marie Massaud
pp. 314-323



Santa Monica Lounge, design J.M. Massaud
pp. 324-331



Santa Monica Home, design J.M. Massaud
pp. 332-339



Bellport, design Jean-Marie Massaud
pp. 340-349



Marlon, design Vincent Van Duysen
pp. 350-361



Ipanema, design Jean-Marie Massaud
pp. 362-373



Ventura Lounge, design Jean-Marie Massaud
pp. 374-385



Camilla, design R&D Poliform
pp. 386-395



Soori Highline, design Soo Chan
pp. 396-405



Gaston, design Vincent Van Duysen
pp. 406-415



BB, design Blumer e Borghi
pp. 416-425



Wallace, design Jean-Marie Massaud
pp. 426-433



Big Bug, design Paola Navone
pp. 434-441

Poliform Spa
via Montesanto 28
Casella postale n. 1
22044 Inverigo (CO) Italy
t +39 031 6951
f +39 031 699444
info@poliform.it
poliform.it



2018 Adi Compasso D'oro
Career Award

Poliform realizza tutte le sue collezioni in Italia usando componenti e materie prime selezionate.

All the Poliform collections are manufactured 100% in Italy using top-class components and materials.

Poliform si riserva il diritto di apportare, senza preavviso, ogni modifica mirata al miglioramento funzionale e qualitativo dei propri prodotti. Testi e disegni presenti in questo stampato hanno scopo divulgativo: per ogni aspetto tecnico e dimensionale fare riferimento ai listini aziendali e relativi aggiornamenti. I campioni di colori e materiali hanno valore indicativo.

Poliform reserves the rights at all time to apply modifications for the functional or qualitative improvement of its products. Texts and drawings present in this brochure have a divulgative purpose: for every technical and dimensional aspect please refer to the company's price lists and their relative updatings. The colour and material samples have an indicative value.

Creative Direction
Apartamento Studios

Graphic Design
Apartamento Studios

Interiors Photography
Federico Cedrone, Omar Sartor

Still Life Photography
Silvia Orlandi

Interiors Styling
Poliform Lab

1st edition April 2019
cod. 107/R1/2019



TWO THOUSAND NINETEEN